

PRODUCT GUIDE

Vol.12

Contact Us

Q-FLEX

www.q-flex.fi info@q-flex.fi

+358 2 4894 500



By bringing together passion and wisdom,
and by connecting one person at a time,
we will innovate and create
a new IRISO for the 21st century.

IRISO CONNECTOR ~connect the future~

IRISO's products connect to the future.



Connect to the future.

Connect technology.
Connect trust.
Connect excitement.
Connecting information, connecting people.
The act of connecting creates new value.
As a leading company in connector development,
we at IRISO connect everything from various digital devices
to the latest applications with our technical capabilities and reliability.
Connect to a better future
We are IRISO.



Table of Contents

Introduction	
Applications	In-Vehicle Applications 02
	ADAS (sensing device) Connectors 04
	Powertrain Connectors 06
	Infotainment (Cockpit) Connectors 08
	Connectors for Household Appliances 10
	Connectors for Commercial Appliances 12
	Connectors for Industrial Equipment 14
Solutions	Automation Connector 16
	Resonance and Vibration Analysis solution 18
Board to Board Connectors 20
	High-Speed Transmission Floating Connectors 21
	Z-Move™ 23
	0.4mm Pitch Floating Connectors 26
	0.5mm Pitch Floating Connectors 28
	0.635mm Pitch Floating Connectors 33
	0.8mm Pitch Floating Connectors 36
	1.0mm Pitch Floating Connectors 39
	2.0mm Pitch 44
	High Current Floating Connectors 45
Pin Header 47
Device Socket	Socket for Power-module connection 50
	Socket for LCD connection 51
Wire Harness Connectors 52
FPC/FFC Connectors 54
	0.3mm Pitch 57
	0.5mm Pitch 57
	1.0mm Pitch 60
	1.25mm Pitch 61
Compression Terminal 62
Card Edge Connectors 67
I/O Connectors 68
High-Speed I/O Connectors 69
ESD Protector Chip 70
Reverse Dictionary 72
Worldwide / Locations 76

Important

■ The information in this catalog is subject to change without notice. Please contact our sales department for details.
■ The information in this catalog reflects typical products. Please contact us if you are looking for a certain series, number of pins, variation, plating, etc.

In-Vehicle Applications

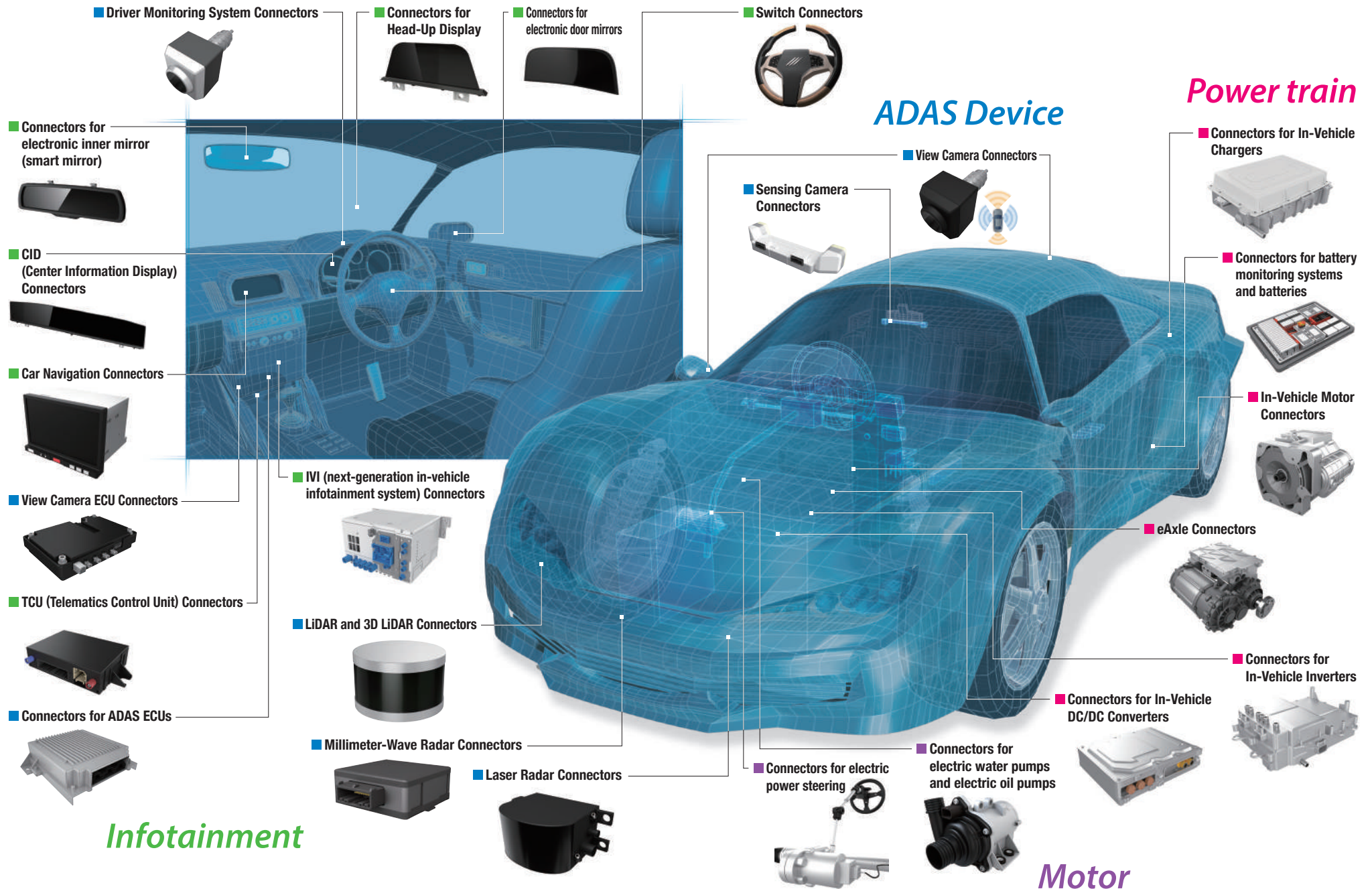

ADAS (sensing device) Connectors

“Recommended products” are for reference only.

Millimeter-Wave Radar Connectors



Recommended products

- 0.4mm Pitch Floating Connectors ... P26
- 0.5mm Pitch Floating Connectors ... P28
- 0.635mm Pitch Floating Connectors ... P33
- 0.8mm Pitch Floating Connectors ... P36
- 1.0mm Pitch Floating Connectors ... P39
- FPC/FFC Connectors ... P54
- Compression Terminal ... P62
- ESD Protector Chip ... P70

Sensing Camera Connectors



Recommended products

- 0.4mm Pitch Floating Connectors ... P26
- FPC/FFC Connectors ... P54
- Compression Terminal ... P62
- ESD Protector Chip ... P70

Connectors for ADAS ECUs

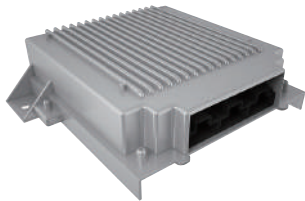

Recommended products

- 0.5mm Pitch Floating Connectors ... P28
- 0.635mm Pitch Floating Connectors ... P33
- 0.8mm Pitch Floating Connectors ... P36
- High Current Floating Connectors ... P45
- Wire Harness Connectors ... P52
- FPC/FFC Connectors ... P54
- Compression Terminal ... P62
- Card Edge Connectors ... P67
- I/O Connectors ... P68
- ESD Protector Chip ... P70

LiDAR and 3D LiDAR Connectors

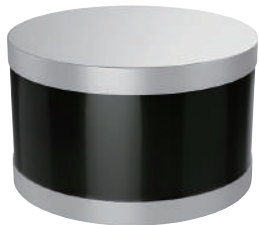

Recommended products

- 0.4mm Pitch Floating Connectors ... P26
- 0.5mm Pitch Floating Connectors ... P28
- 0.635mm Pitch Floating Connectors ... P33
- 0.8mm Pitch Floating Connectors ... P36
- FPC/FFC Connectors ... P54
- Compression Terminal ... P62
- ESD Protector Chip ... P70

Laser Radar Connectors



Recommended products

- 0.4mm Pitch Floating Connectors ... P26
- 0.5mm Pitch Floating Connectors ... P28
- 0.635mm Pitch Floating Connectors ... P33
- 0.8mm Pitch Floating Connectors ... P36
- 1.0mm Pitch Floating Connectors ... P39
- FPC/FFC Connectors ... P54
- Compression Terminal ... P62
- ESD Protector Chip ... P70

View Camera Connectors



Recommended products

- 0.4mm Pitch Floating Connectors ... P26
- FPC/FFC Connectors ... P54
- Compression Terminal ... P62
- ESD Protector Chip ... P70

View Camera ECU Connectors

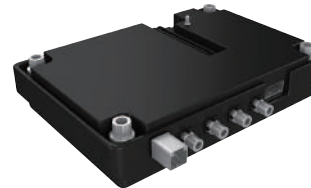

Recommended products

- High Current Floating Connectors ... P45
- Wire Harness Connectors ... P52
- FPC/FFC Connectors ... P54
- Compression Terminal ... P62
- Card Edge Connectors ... P67
- I/O Connectors ... P68
- ESD Protector Chip ... P70

Driver Monitoring System Connectors



Recommended products

- 0.4mm Pitch Floating Connectors ... P26
- 0.5mm Pitch Floating Connectors ... P28
- 0.635mm Pitch Floating Connectors ... P33
- 0.8mm Pitch Floating Connectors ... P36
- 1.0mm Pitch Floating Connectors ... P39
- FPC/FFC Connectors ... P54
- Compression Terminal ... P62
- ESD Protector Chip ... P70

Connectors for battery monitoring systems and batteries

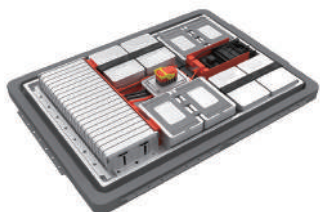

Recommended products

- Z-Move™ ... P23
- 0.5mm Pitch Floating Connectors ... P28
- 0.635mm Pitch Floating Connectors ... P33
- 0.8mm Pitch Floating Connectors ... P36
- 1.0mm Pitch Floating Connectors ... P39
- High Current Floating Connectors ... P45
- Wire Harness Connectors ... P52
- FPC/FFC Connectors ... P54
- ESD Protector Chip ... P70

Connectors for In-Vehicle Chargers



Recommended products

- Z-Move™ ... P23
- 0.5mm Pitch Floating Connectors ... P28
- 0.635mm Pitch Floating Connectors ... P33
- 0.8mm Pitch Floating Connectors ... P36
- 1.0mm Pitch Floating Connectors ... P39
- High Current Floating Connectors ... P45
- Device Socket ... P50
- Wire Harness Connectors ... P52
- FPC/FFC Connectors ... P54
- ESD Protector Chip ... P70

Connectors for In-Vehicle DC/DC Converters



Recommended products

- Z-Move™ ... P23
- High Current Floating Connectors ... P45
- Device Socket ... P50
- Wire Harness Connectors ... P52
- FPC/FFC Connectors ... P54
- ESD Protector Chip ... P70

Connectors for In-Vehicle Inverters

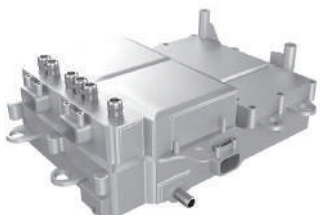

Recommended products

- Z-Move™ ... P23
- High Current Floating Connectors ... P45
- Device Socket ... P50
- Wire Harness Connectors ... P52
- FPC/FFC Connectors ... P54
- ESD Protector Chip ... P70

Connectors for electric power steering



Recommended products

- Z-Move™ ... P23
- High Current Floating Connectors ... P45
- Device Socket ... P50
- ESD Protector Chip ... P70

In-Vehicle Motor Connectors

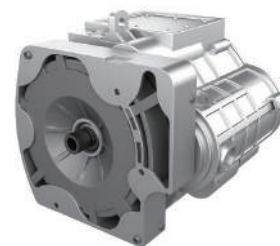

Recommended products

- Z-Move™ ... P23
- High Current Floating Connectors ... P45
- Device Socket ... P50
- Wire Harness Connectors ... P52
- ESD Protector Chip ... P70

Connectors for electric water pumps and electric oil pumps



Recommended products

- Z-Move™ ... P23
- High Current Floating Connectors ... P45
- Device Socket ... P50
- ESD Protector Chip ... P70

eAxle Connectors



Recommended products

- Z-Move™ ... P23
- High Current Floating Connectors ... P45
- Device Socket ... P50
- Wire Harness Connectors ... P52
- ESD Protector Chip ... P70

Infotainment (Cockpit) Connectors

“Recommended products” are for reference only.

Connectors for Head-Up Display



Recommended products

- 0.5mm Pitch Floating Connectors ... P28
- 0.635mm Pitch Floating Connectors ... P33
- 0.8mm Pitch Floating Connectors ... P36
- 1.0mm Pitch Floating Connectors ... P39
- Device Socket ... P50
- FPC/FFC Connectors ... P54
- Compression Terminal ... P62
- I/O Connectors ... P68
- ESD Protector Chip ... P70

IVI (next-generation in-vehicle infotainment system) Connectors



Recommended products

- 0.5mm Pitch Floating Connectors ... P28
- 0.635mm Pitch Floating Connectors ... P33
- 0.8mm Pitch Floating Connectors ... P36
- 1.0mm Pitch Floating Connectors ... P39
- High Current Floating Connectors ... P45
- FPC/FFC Connectors ... P54
- Compression Terminal ... P62
- Card Edge Connectors ... P67
- I/O Connectors ... P68
- ESD Protector Chip ... P70

TCU (Telematics Control Unit) Connectors



Recommended products

- 0.5mm Pitch Floating Connectors ... P28
- 0.635mm Pitch Floating Connectors ... P33
- 0.8mm Pitch Floating Connectors ... P36
- 1.0mm Pitch Floating Connectors ... P39
- Device Socket ... P50
- Wire Harness Connectors ... P52
- FPC/FFC Connectors ... P54
- Compression Terminal ... P62
- Card Edge Connectors ... P67
- I/O Connectors ... P68
- ESD Protector Chip ... P70

CID (Center Information Display) Connectors



Recommended products

- 0.5mm Pitch Floating Connectors ... P28
- 0.635mm Pitch Floating Connectors ... P33
- 0.8mm Pitch Floating Connectors ... P36
- 1.0mm Pitch Floating Connectors ... P39
- Device Socket ... P50
- FPC/FFC Connectors ... P54
- Compression Terminal ... P62
- Card Edge Connectors ... P67
- I/O Connectors ... P68
- ESD Protector Chip ... P70

Switch Connectors



Recommended products

- 1.0mm Pitch Floating Connectors ... P39
- Device Socket ... P50
- FPC/FFC Connectors ... P54
- ESD Protector Chip ... P70

Connectors for electronic inner mirror (smart mirror)



Recommended products

- 0.4mm Pitch Floating Connectors ... P26
- 0.5mm Pitch Floating Connectors ... P28
- 0.635mm Pitch Floating Connectors ... P33
- 0.8mm Pitch Floating Connectors ... P36
- 1.0mm Pitch Floating Connectors ... P39
- FPC/FFC Connectors ... P54
- Compression Terminal ... P62
- I/O Connectors ... P68
- ESD Protector Chip ... P70

Connectors for electronic door mirrors



Recommended products

- FPC/FFC Connectors ... P54
- ESD Protector Chip ... P70

Car Navigation Connectors



Recommended products

- 0.5mm Pitch Floating Connectors ... P28
- 0.635mm Pitch Floating Connectors ... P33
- 0.8mm Pitch Floating Connectors ... P36
- 1.0mm Pitch Floating Connectors ... P39
- High Current Floating Connectors ... P45
- Device Socket ... P50
- Wire Harness Connectors ... P52
- FPC/FFC Connectors ... P54
- Compression Terminal ... P62
- Card Edge Connectors ... P67
- I/O Connectors ... P68
- ESD Protector Chip ... P70

Connectors for Household Appliances

“Recommended products” are for reference only.

Smartphone and Mobile Phone Connectors



Recommended products

- 0.4mm Pitch Floating Connectors ... P26
- FPC/FFC Connectors ... P54
- Compression Terminal ... P62
- ESD Protector Chip ... P70

Console Gaming Connectors



Recommended products

- 0.5mm Pitch Floating Connectors ... P28
- 0.635mm Pitch Floating Connectors ... P33
- 0.8mm Pitch Floating Connectors ... P36
- 1.0mm Pitch Floating Connectors ... P39
- FPC/FFC Connectors ... P54
- Compression Terminal ... P62
- ESD Protector Chip ... P70

Digital Camera Connectors



Recommended products

- 0.4mm Pitch Floating Connectors ... P26
- FPC/FFC Connectors ... P54
- Compression Terminal ... P62
- ESD Protector Chip ... P70

Home Appliance Connectors



Recommended products

- 0.5mm Pitch Floating Connectors ... P28
- 0.635mm Pitch Floating Connectors ... P33
- 0.8mm Pitch Floating Connectors ... P36
- 1.0mm Pitch Floating Connectors ... P39
- Device Socket ... P50
- FPC/FFC Connectors ... P54
- Compression Terminal ... P62
- I/O Connectors ... P68
- ESD Protector Chip ... P70

Audiovisual Connectors



Recommended products

- 0.5mm Pitch Floating Connectors ... P28
- 0.635mm Pitch Floating Connectors ... P33
- 0.8mm Pitch Floating Connectors ... P36
- 1.0mm Pitch Floating Connectors ... P39
- Device Socket ... P50
- FPC/FFC Connectors ... P54
- Compression Terminal ... P62
- I/O Connectors ... P68
- ESD Protector Chip ... P70

Headphone Connectors



Recommended products

- 0.4mm Pitch Floating Connectors ... P26
- FPC/FFC Connectors ... P54
- Compression Terminal ... P62
- ESD Protector Chip ... P70

Notebook PC Connectors



Recommended products

- 0.4mm Pitch Floating Connectors ... P26
- FPC/FFC Connectors ... P54
- Compression Terminal ... P62
- Card Edge Connectors ... P67
- ESD Protector Chip ... P70

Communication Robot Connectors



Recommended products

- Z-Move™ ... P23
- 0.4mm Pitch Floating Connectors ... P26
- 0.5mm Pitch Floating Connectors ... P28
- 0.635mm Pitch Floating Connectors ... P33
- 0.8mm Pitch Floating Connectors ... P36
- 1.0mm Pitch Floating Connectors ... P39
- High Current Floating Connectors ... P45
- Device Socket ... P50
- FPC/FFC Connectors ... P54
- Compression Terminal ... P62
- Card Edge Connectors ... P67
- I/O Connectors ... P68
- ESD Protector Chip ... P70

Connectors for Commercial Appliances

“Recommended products” are for reference only.

Connectors for All-In-One and Multifunction Printers



Recommended products

- 0.5mm Pitch Floating Connectors ... P28
- 0.635mm Pitch Floating Connectors ... P33
- 0.8mm Pitch Floating Connectors ... P36
- 1.0mm Pitch Floating Connectors ... P39
- High Current Floating Connectors ... P45
- Device Socket ... P50
- FPC/FFC Connectors ... P54
- Compression Terminal ... P62
- I/O Connectors ... P68
- ESD Protector Chip ... P70

Surveillance Camera Connectors



Recommended products

- Z-Move™ ... P23
- 0.4mm Pitch Floating Connectors ... P26
- 0.5mm Pitch Floating Connectors ... P28
- 0.635mm Pitch Floating Connectors ... P33
- 0.8mm Pitch Floating Connectors ... P36
- 1.0mm Pitch Floating Connectors ... P39
- Device Socket ... P50
- FPC/FFC Connectors ... P54
- Compression Terminal ... P62
- I/O Connectors ... P68
- ESD Protector Chip ... P70

Pachinko Connectors



Recommended products

- Z-Move™ ... P23
- 0.5mm Pitch Floating Connectors ... P28
- 0.635mm Pitch Floating Connectors ... P33
- 0.8mm Pitch Floating Connectors ... P36
- 1.0mm Pitch Floating Connectors ... P39
- Device Socket ... P50
- FPC/FFC Connectors ... P54
- Compression Terminal ... P62
- Card Edge Connectors ... P67
- I/O Connectors ... P68
- ESD Protector Chip ... P70

POS System Connectors



Recommended products

- 0.5mm Pitch Floating Connectors ... P28
- 0.635mm Pitch Floating Connectors ... P33
- 0.8mm Pitch Floating Connectors ... P36
- 1.0mm Pitch Floating Connectors ... P39
- Device Socket ... P50
- FPC/FFC Connectors ... P54
- Compression Terminal ... P62
- I/O Connectors ... P68
- ESD Protector Chip ... P70

Barcode Reader Connectors



Recommended products

- 0.5mm Pitch Floating Connectors ... P28
- 0.635mm Pitch Floating Connectors ... P33
- 0.8mm Pitch Floating Connectors ... P36
- 1.0mm Pitch Floating Connectors ... P39
- Device Socket ... P50
- FPC/FFC Connectors ... P54
- Compression Terminal ... P62
- I/O Connectors ... P68
- ESD Protector Chip ... P70

Commercial Drone Connectors



Recommended products

- Z-Move™ ... P23
- 0.5mm Pitch Floating Connectors ... P28
- 0.635mm Pitch Floating Connectors ... P33
- 0.8mm Pitch Floating Connectors ... P36
- 1.0mm Pitch Floating Connectors ... P39
- Device Socket ... P50
- FPC/FFC Connectors ... P54
- Compression Terminal ... P62
- I/O Connectors ... P68
- ESD Protector Chip ... P70

ATM Connectors



Recommended products

- Z-Move™ ... P23
- 0.5mm Pitch Floating Connectors ... P28
- 0.635mm Pitch Floating Connectors ... P33
- 0.8mm Pitch Floating Connectors ... P36
- 1.0mm Pitch Floating Connectors ... P39
- High Current Floating Connectors ... P45
- Device Socket ... P50
- FPC/FFC Connectors ... P54
- Compression Terminal ... P62
- I/O Connectors ... P68
- ESD Protector Chip ... P70

Module Connectors



Recommended products

- Device Socket ... P50
- FPC/FFC Connectors ... P54
- Compression Terminal ... P62
- ESD Protector Chip ... P70

Connectors for Industrial Equipment

“Recommended products” are for reference only.

Connectors for mobile phone base station infrastructure equipment



Recommended products

- 0.4mm Pitch Floating Connectors ... P26
- High Current Floating Connectors ... P45
- Compression Terminal ... P62
- ESD Protector Chip ... P70

Industrial Inverter Connectors



Recommended products

- 0.5mm Pitch Floating Connectors ... P28
- 0.635mm Pitch Floating Connectors ... P33
- 0.8mm Pitch Floating Connectors ... P36
- 1.0mm Pitch Floating Connectors ... P39
- High Current Floating Connectors ... P45
- Device Socket ... P50
- Wire Harness Connectors ... P52
- FPC/FFC Connectors ... P54
- Compression Terminal ... P62
- ESD Protector Chip ... P70

Smart Grid (meter) Connectors



Recommended products

- 0.5mm Pitch Floating Connectors ... P28
- 0.635mm Pitch Floating Connectors ... P33
- 0.8mm Pitch Floating Connectors ... P36
- 1.0mm Pitch Floating Connectors ... P39
- High Current Floating Connectors ... P45
- Device Socket ... P50
- FPC/FFC Connectors ... P54
- Compression Terminal ... P62
- I/O Connectors ... P68
- ESD Protector Chip ... P70

Connectors for servo amplifiers and motors



Recommended products

- Z-Move™ ... P23
- 0.5mm Pitch Floating Connectors ... P28
- 0.635mm Pitch Floating Connectors ... P33
- 0.8mm Pitch Floating Connectors ... P36
- 1.0mm Pitch Floating Connectors ... P39
- High Current Floating Connectors ... P45
- Device Socket ... P50
- FPC/FFC Connectors ... P54
- Compression Terminal ... P62
- ESD Protector Chip ... P70

Connectors for flowmeter, solenoid valve, pressure gauge



Recommended products

- Z-Move™ ... P23
- 0.4mm Pitch Floating Connectors ... P26
- 0.5mm Pitch Floating Connectors ... P28
- 0.635mm Pitch Floating Connectors ... P33
- 0.8mm Pitch Floating Connectors ... P36
- 1.0mm Pitch Floating Connectors ... P39
- High Current Floating Connectors ... P45
- Device Socket ... P50
- FPC/FFC Connectors ... P54
- Compression Terminal ... P62
- ESD Protector Chip ... P70

Connectors for Measuring and Inspection Equipment



Recommended products

- 0.4mm Pitch Floating Connectors ... P26
- 0.5mm Pitch Floating Connectors ... P28
- 0.635mm Pitch Floating Connectors ... P33
- 0.8mm Pitch Floating Connectors ... P36
- 1.0mm Pitch Floating Connectors ... P39
- High Current Floating Connectors ... P45
- Device Socket ... P50
- FPC/FFC Connectors ... P54
- Compression Terminal ... P62
- Card Edge Connectors ... P67
- I/O Connectors ... P68
- ESD Protector Chip ... P70

Medical Device Connectors



Recommended products

- 0.4mm Pitch Floating Connectors ... P26
- 0.5mm Pitch Floating Connectors ... P28
- 0.635mm Pitch Floating Connectors ... P33
- 0.8mm Pitch Floating Connectors ... P36
- 1.0mm Pitch Floating Connectors ... P39
- High Current Floating Connectors ... P45
- Device Socket ... P50
- FPC/FFC Connectors ... P54
- Compression Terminal ... P62
- Card Edge Connectors ... P67
- I/O Connectors ... P68
- ESD Protector Chip ... P70

Industrial Robot Connectors



Recommended products

- Z-Move™ ... P23
- 0.5mm Pitch Floating Connectors ... P28
- 0.635mm Pitch Floating Connectors ... P33
- 0.8mm Pitch Floating Connectors ... P36
- 1.0mm Pitch Floating Connectors ... P39
- High Current Floating Connectors ... P45
- Device Socket ... P50
- FPC/FFC Connectors ... P54
- Compression Terminal ... P62
- Card Edge Connectors ... P67
- I/O Connectors ... P68
- ESD Protector Chip ... P70

Automation Connector



What is an Automation Connector?

Currently, demand for industrial robots is growing rapidly. Robotic production contributes to stabilizing assembly quality and production takt time, as well as limiting increases in labor wages. However, in-process defects such as foreign matter adhesion, mounting and mating misalignment, and incomplete mating can still occur. Therefore, IRISO has launched a new concept, Automation Connector, based on technology it has developed, with the aim of widely promoting connectors that are suitable for robot production. Automation Connector are composed of three technologies developed by IRISO Electronics to meet a wide range of customers' robot production needs.

Three technologies make up the Automation Connector

1 Floating Connector

IRISO Electronics is proud to offer the industry's largest variety of floating connectors with movable connection surfaces when mated. These floating connectors absorb the misalignment of boards and reduce the stress on soldered parts. The floating connectors prevent solder cracks. Furthermore, it is possible to mount multiple connectors on the same board and fit them together. A wide range of variations are available to meet customers' needs.



What is a floating connector?

"Floating connector" is a generic term for connectors with a floating structure that can be moved between rows and in the pitch direction (X-Y axis) by installing a movable spring on the terminal. Most common board-to-board connectors are rigid types that do not have a movable spring and cannot be mated if the connector is misaligned with the board. Floating connectors, however, can be mated normally because they are equipped with a floating mechanism that absorbs errors even if their positions are misaligned. A movable connector absorbs board misalignment and reduces stress on the solder joint. Prevents poor contact due to solder cracks or other defects.

Advantages of using floating connectors

Floating connectors can be used to solve a variety of problems.

- Absorbs misalignment after mating and reduces stress on solder joint to minimize cracking.
- Multiple connectors can be used on the same board.
- Increases the flexibility in board layout and circuit design.
- Absorbs misalignment during mating by robotic assembly and contributes to automation.

We at IRISO have launched our concept of Connectors for Robotic Assembly based on technology we developed, with the aim of widely promoting connectors that are suitable for robot production, and are gaining recognition from customers, academic institutes, and media. Since we are expanding globally, we have changed the name to "Automation Connectors," and are making effort to spread understanding of this concept throughout the world.

Automation Connector

2 Auto I-Lock™

Until now, robotic assembly with FPC/FFC cards was considered impossible, but IRISO Electronics' FPC/FFC connector Auto I-Lock™ automatically locks when an FPC/FFC card is inserted, ensuring secure mating. Robotic assembly is possible even when using FPC/FFC cards.

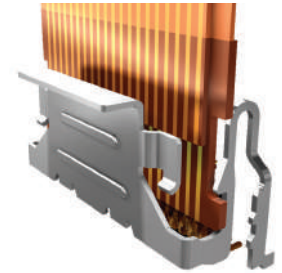

What is Auto I-Lock™?

Auto I-Lock™ is a connector that automatically locks when an FPC/FFC card is inserted. The structure eliminates the slider and cover opening/closing motion and locks as soon as the FPC/FFC card is inserted, preventing skewed insertion and incomplete mating and improving work efficiency. Secure mating enables robotic assembly even when using FPC/FFC cards.

Advantages of using Auto I-Lock™

Auto I-Lock™ can be used to solve a variety of problems.

- Prevents incomplete mating, reduces inspection processes, and improves productivity.
- Proprietary terminal structure enables high-speed transmission of digital signals.
- GND terminal is provided for noise suppression when shielded FFC is used.
- Automatic locking enables robotic assembly. Contributes to automation.

3 Two-point contact connector

The two-point contact connector concept of IRISO Electronics is to have two-point contact on the same line. The ability to remove suspended solids and scattered flux foreign matter, assures consistent contact with reliable wiping. Adoption of two-point contact connectors improved contact reliability, which in turn improves yield and contributes to total cost reduction.



What is a two-point contact structure?

The "two-point contact structure" concept is to have two-point contact on the same line. It removes suspended solids, scattered flux, and other foreign matter, and assures stable contact through reliable wiping. Even if one terminal contact runs onto an adhered object, the other terminal contact of the two-point contact connector will ensure continuity and prevent poor contact. Adoption of two-point contact connectors improved contact reliability, which in turn improves yield and contributes to total cost reduction.

Advantages of using two-point contact connectors

Two-point contact connectors can be used to solve a variety of problems.

- Two-point contact structure (two-point contact on the same line) prevents poor contact.
- Removes foreign matter during mating even in environments prone to contamination.
- Improved yield rate, contributing to total cost reduction.
- Absorbs misalignment during mating by robotic assembly and contributes to automation.

Resonance and Vibration Analysis Solutions

Simulation

What is Z-Move™?

In addition to a floating structure that allows X- and Y-axis movement, IRISO Electronics' Z-Move™ connector has a structure that allows Z-axis movement while the contact point remains fixed, enabling absorption of minute board amplitudes caused by resonance in the high vibration frequency range. Prevents loss of contact reliability due to fine sliding wear. Meets critical safety component standards for in-vehicle mounting and greatly improves ease of handling and reliability.

Advantages of using Z-Move™

Z-Move™ can be used to solve a variety of problems.

- Movement in the Z-axis direction allows connectors to be used for equipment affected by vibrations.
- Prevents poor contact due to vibrations/load after the set is completed.
- Our proprietary vibration simulation service allows us to make proposals from the early design stage.
- Designed for high heat resistance, enabling use in harsh, high-temperature environments.
- Absorbs misalignment during mating by robotic assembly and contributes to automation.

What is resonant vibration?

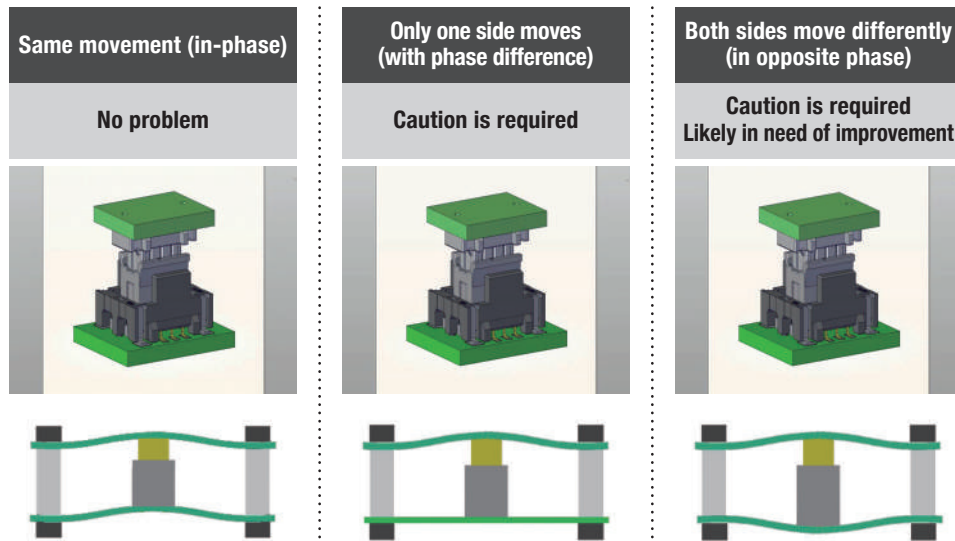

Resonance and Vibration Analysis Solutions

What is resonance?

Natural vibrations are caused by an external stimulus. Some are mechanical and some are electrical. "Objects" have natural frequencies based on their mass, size, etc., and are prone to resonance, especially when external stimuli match these natural frequencies. On the other hand, at the frequency where the inductance and capacitance exactly cancel each other, the element impedance becomes minimal and resonance occurs. Reflections at multiple points along the transmission path cause resonance at the frequency of the phase at which the reflected waves strengthen each other, which is applied by antennas. In cases where it is not the intended, it can also be a source (or receiver) of noise. IRISO offers the Z-Move™ series of anti-vibration connectors. We also provide vibration analysis and other support services upon customer request.

Assistance with design optimization for vibration

1 The customer provides us with 3D data, vibration conditions, physical properties, and fixed conditions.

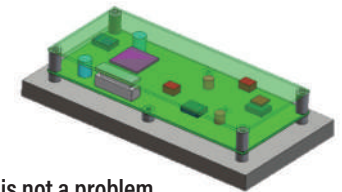

2 Vibration analysis is performed to confirm that gap variation is not a problem.

If consideration is needed, analysis of proposal for additional fixing or relocation of connectors is performed.

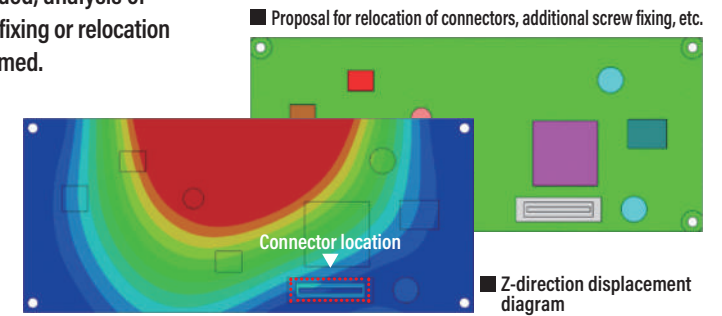

3 Prevent design rework due to resonance by helping customers complete their set design!

■ Before vibration countermeasures

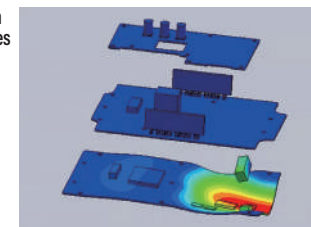

■ After vibration countermeasures

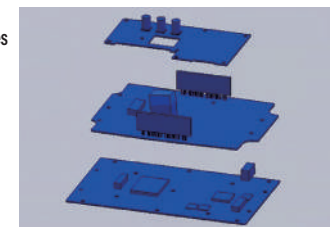

Board-to-Board Connectors (BtoB®)

What is a floating connector?

Board-to-board connectors have two types of mechanisms: rigid and floating. The rigid type connector is a proven connection method used for board-to-board connections of general board-to-board connectors. As the name "rigid" implies, the mechanism has no range of motion. Floating type connectors have a spring that absorbs misalignment and errors without moving the contacts when mating connectors.

Why are floating connectors used?

Three reasons to use floating type connectors

1 Reduces stress on solder joint due to misalignment

Rigid type connectors will not engage and mate if there is a misalignment or error during mounting on the board. In addition, forcibly correcting the misalignment and attempting to mate under these conditions may put stress on the solder joint and lead to problems such as solder cracks. Floating type connectors have a spring structure that allows the mating part to move, so that any misalignment or error is absorbed within the connector and the connector can be mated in a correct position. This structure reduces stress on the solder joint and minimizes solder cracking. It also prevents cracks and other defects in the circuit board.

2 Absorbs misalignment errors and can be used in multiple connectors

As described above, floating connectors can absorb misalignment, allowing multiple connectors to be used on the same board. Conventional rigid type connectors could not absorb connector misalignment, making it difficult to use multiple connectors, but the floating connector structure overcomes this problem. This allows greater flexibility in layout and circuit design for applications.

3 Automatic assembly available

In the past, mating using assembly robots could cause problems such as stress on the connector itself due to an oblique mating or solder cracks. The use of floating connectors during robot assembly absorbs errors and mating misalignments that cannot be corrected by the robot and relieves stress concentrated on the connectors and solder joints. A guiding structure is designed in the frontage of housing, which eliminates stress at the time of mating.

IRISO Floating Connectors

The strength of IRISO's floating connectors lies in its industry-leading product lineup, which boasts unrivaled variation of 0.4mm to 2.0mm pitch and 3mm to 30mm mating height, with parallel and vertical mating types depending on the combination of socket and plug. With cumulative sales exceeding 3 billion units, IRISO Electronics' floating connectors continue to evolve based on customer feedback, and we will continue our research and development of this connection method for a variety of devices.

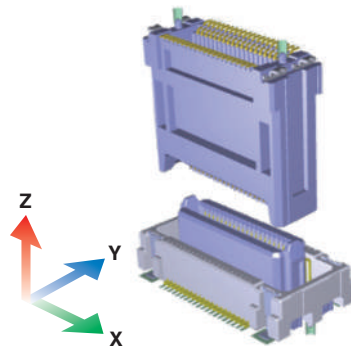

High-Speed Transmission Floating Connectors ··· Board to Board Connectors

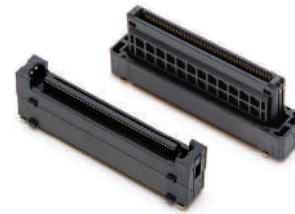

This product line supports high-speed transmission while retaining the excellent features of previous products, such as floating connectors and Auto I-Lock™ structure. Even with terminals with complex structures, the impedance profile is stable, allowing for high-speed transmission at a high level.

- Minimizing signal degradation creates more room in your SI budget.
- Supports a variety of evaluations.

Feature 1 Floating

The floating board-to-board connector (BtoB) moves in the X and Y directions and absorbs misalignment between boards, facilitating alignment adjustment when connecting multiple boards and relieving stress concentrated on the soldered part. In addition, it greatly contributes to the improvement of fitting workability in addition to appropriate invitation. The 10143 Series realizes a movable amount that exceeds the pitch width. It can move 0.8 mm in the X and Y directions.

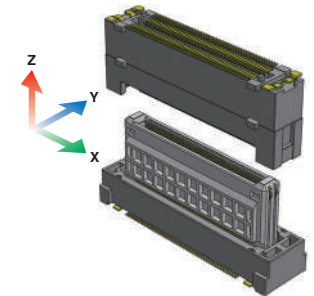

Feature 2 High Speed Transmission

The recent trend towards more sophisticated devices and an increase in the amount of information being transmitted has spurred demand for high-speed transmission in connecting components. In addition, the increase in high-frequency components in signals has led to situations where attention must be paid to minute details that were previously not an issue. Products compatible with high-speed transmission are optimally designed by organically combining numerous on-site evaluations and simulations. The 10143 series supports various transmission standards including PCIe Gen 4, achieving high-speed transmission of up to 25 Gbps*. Another major feature is that it combines high reliability and ease of use by combining IRISO Electronics' Floating structure technology with high-speed transmission.

*When measured according to the "OIF CEI-28G-SR" standard

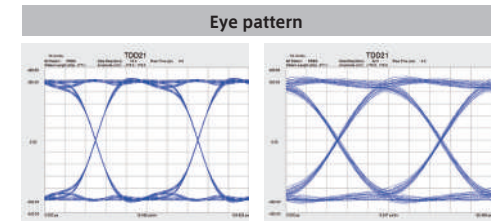
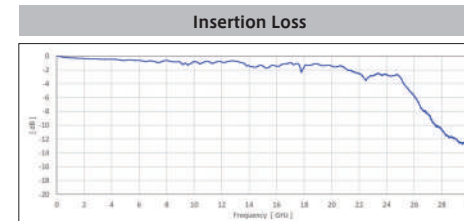

Feature 3 Power Contact

By locating the power terminals on both ends of the product, there is no need to allocate terminals for power supply, which contributes to miniaturizing the connector. This power terminal also serves as a fixing bracket, making it possible to miniaturize the entire connector, thereby reducing the area that the connector occupies on the board.

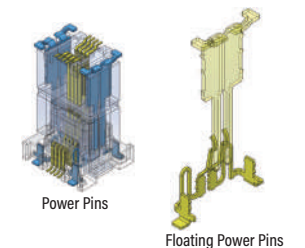

High-Speed Transmission Floating Connectors Board to Board Connectors

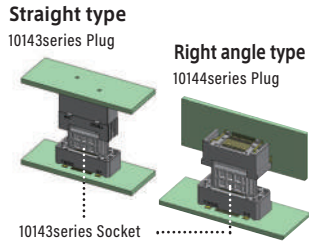

10143/10144 Series

Floating connectors with a pitch of 0.5mm for high-speed transmission of digital signals. The floating structure allows 0.8mm of movement in X-Y direction. About ±0.5mm is absorbed in the Z direction as the mating length. "Hybrid" connector that achieves both high-speed transmission at 25Gbps* along with a floating structure that allows for a large range of motion. Power source terminals with a fixing bracket function are installed at both ends of the connectors.

■ We have developed 104 items including 24 variations of mating heights and expanded number of poles.

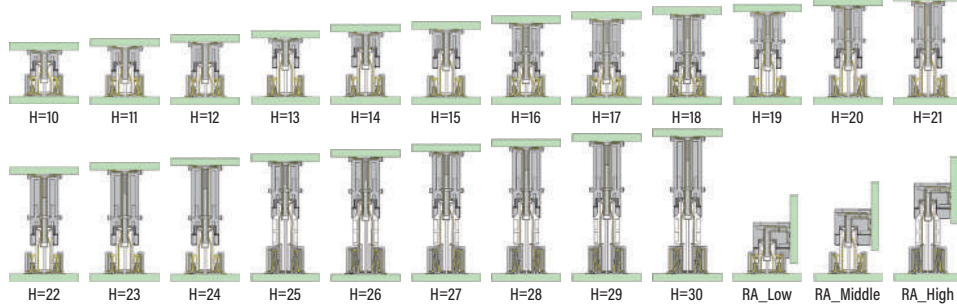

10143B - 10143S 0.5 Pitch

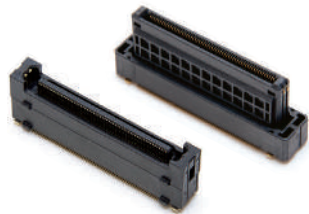

Pitch (mm)	0.5
Mating direction (ST/RA)	ST-ST
Pins	20~160
X/Y-Axis Floating Range (mm)	0.8
Rated voltage (V (AC/DC))	50
Rated current (A)	0.5/3.0
Transmission characteristics (Gbps)	25
Operating temperature range (°C)	-40~125

10144B - 10143S 0.5 Pitch

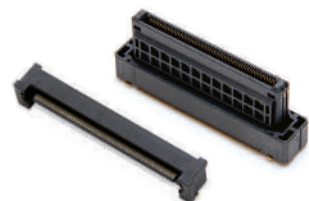

Pitch (mm)	0.5
Mating direction (ST/RA)	RA-ST
Pins	20~160
X/Y-Axis Floating Range (mm)	0.8
Rated voltage (V (AC/DC))	50
Rated current (A)	0.5/3.0
Transmission characteristics (Gbps)	25
Operating temperature range (°C)	-40~125

Z-Move™ Board to Board Connectors

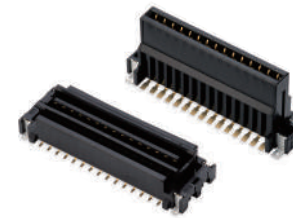

Internal contact board-to-board (BtoB®) Z-movable floating type connector for use in extreme vibration environments. IRISO's proprietary floating technology "Z-Move™" is used (registered trademark). Z-axis is movable with fixed contact points. This connector has excellent resistance to vibration and shocks. Relieves stress on solder joints due to vibration (resonance) and shocks. It greatly improves ease of handling and reliability.

*P50 Please refer to the Socket 18021 series with Z-Move™ function.

Feature 1 Z-Move™ Vibration

IRISO's proprietary "Z-Move™" technology absorbs board resonance and provides high contact reliability because the contacts follow resonance in the Z direction. This prevents loss of contact reliability due to fine sliding wear. IRISO also offers a proprietary vibration simulation service that reflects the previous evaluation results. By working with the customer from the initial stages of design, we are able to suggest more effective uses.

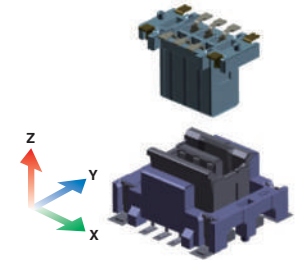

Feature 2 High Temperature

The rising amount of heat generated around engines in in-vehicle equipment and the increasing sophistication of devices have increased the need for connectors to have high heat resistance. These highly heat-resistant products created with our material and design technologies can be used with confidence even in harsh, high-temperature environments.

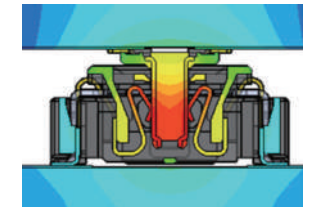

Feature 3 Two-Point Contact

The two-point contact offered by IRISO provides a secure connection even in environments that are prone to dust and dirt by reliably removing foreign matter at the front contact. It can be used with confidence for devices that require high connection reliability.

Before mating

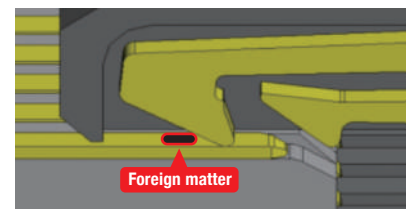

After mating

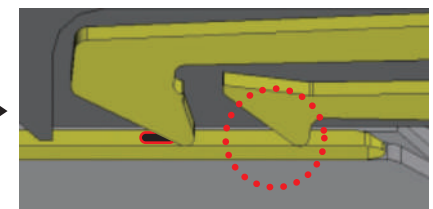

Z-Move™ Board to Board Connectors

10120 Series

2.0mm pitch, Z-movable (Z-Move™) floating type parallel connection (ST/ST) BtoB® connector. Seamless board-to-board distance support; 5 types of sockets and 2 types of plugs available. Available in 1mm increments from 11mm to 20mm depending on the combination. Number of pins: 6, 10, 20, 30 pins available. Compatible with in-vehicle environments. 125°C rated, suitable for board connections around powertrain.

■ **Combination and board-to-board distance, selectable number of pins**
The board-to-board distances for each socket and plug combination are as follows.

Board-to-board distance matrix	10120B	
10120S	11mm	12mm
	13mm	14mm
	15mm	16mm
	17mm	18mm
	19mm	20mm

10127 Series

2.0mm pitch, Z-movable (Z-Move™) floating type parallel connection (ST/ST) BtoB® connector. Low profile design for 8mm board-to-board distance; used for shorter board-to-board distance than the standard type (10120 series). Number of pins: 8-pin products are in production (6- and 10-pin products are under development). 125°C rated for in-vehicle environments.

Board-to-board distance matrix	10127B
10127S	8mm

*We can simulate the fixing method that best fits your equipment using IRISO's proprietary analysis system.

10128 Series

Z-movable (Z-Move™) floating type parallel connection (ST/ST) BtoB® connectors with an extremely small 0.8 mm pitch. 0.8mm pitch reduces mounting density; occupies about 50% of board space compared to the 2.0mm pitch standard type (10120 series). Number of pins: Narrow pitch multi-pin (30 and 50-pin products in mass production). Heat resistant, rated 125°C for in-vehicle environments.

■ **Combination and board-to-board distance, selectable number of pins**
The board-to-board distances for each socket and plug combination are as follows.

Board-to-board distance matrix	10128B	
10128S	17mm	18mm
	19mm	20mm
	21mm	22mm
	23mm	24mm
	25mm	26mm

10133 Series

Z-movable (Z-Move™) floating type parallel connection (ST/ST) BtoB® connectors with an extremely small 0.5 mm pitch. 0.5mm pitch reduces mounting density; mating with the existing 9984 series is now possible with a lineup of 12mm to 20mm. Number of pins: Narrow pitch multi-pin (40-pin product in mass production). Highly heat resistant, rated 125°C for in-vehicle environments.

■ **Combination and board-to-board distance, selectable number of pins**
The board-to-board distances for each socket and plug combination are as follows.

Board-to-board distance matrix	10133B
9984S	12mm
	14mm
	16mm
	18mm
	20mm

*This product is available in a variety of combinations. See the website (Floating Connector Selection Guide) for more information.

Board to Board Connectors

10120B - 10120S

Z-Move™ 2-point contact High Temp 2.0 Pitch

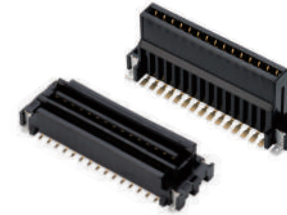

Pitch (mm)	2.0
Mating direction (ST/RA)	ST
Pins	6~30
X/Y-Axis Floating Range (mm)	0.65
Rated voltage (V (AC/DC))	125
Rated current (A)	1.0
Transmission characteristics (Gbps)	—
Operating temperature range (°C)	-40~125

10127B - 10127S

Z-Move™ 2-point contact High Temp 2.0 Pitch

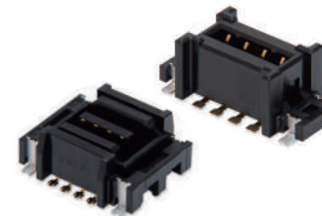

Pitch (mm)	2.0
Mating direction (ST/RA)	ST
Pins	6/8/10
X/Y-Axis Floating Range (mm)	0.5
Rated voltage (V (AC/DC))	125
Rated current (A)	0.3
Transmission characteristics (Gbps)	—
Operating temperature range (°C)	-40~125

10128B - 10128S

Z-Move™ 2-point contact High Temp 0.8 Pitch



Pitch (mm)	0.8
Mating direction (ST/RA)	ST
Pins	30/50
X/Y-Axis Floating Range (mm)	0.5
Rated voltage (V (AC/DC))	125
Rated current (A)	0.5
Transmission characteristics (Gbps)	—
Operating temperature range (°C)	-40~125

10133B - 9984S

Z-Move™ 2-point contact High speed High Temp 0.5 Pitch

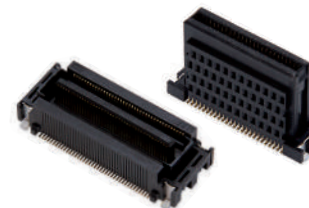

Pitch (mm)	0.5
Mating direction (ST/RA)	ST
Pins	40
X/Y-Axis Floating Range (mm)	0.5
Rated voltage (V (AC/DC))	50
Rated current (A)	0.4
Transmission characteristics (Gbps)	—
Operating temperature range (°C)	-40~125

0.4mm Pitch Floating Connectors ... Board to Board Connectors



0.4mm pitch, floating type parallel connection (ST/ST) BtoB® connectors for high-speed transmission of digital signals. Floating structure allows 0.4mm of movement in X-Y direction. Effective mating length of 0.3mm in Z direction. Supports high-speed transmission despite its low profile and compact design. Supports high-speed transmission at MAX 10Gbps (typical reference value based on in-house definition). Impedance matching: Differential 100 ohm. Absorbs optical axis misalignment during module board integration of in-vehicle cameras, greatly improving reliability.

Feature 1 High Temperature

The rising amount of heat generated around engines in in-vehicle equipment and the increasing sophistication of devices have increased the need for connectors to have high heat resistance. These highly heat-resistant products created with our material and design technologies can be used with confidence even in harsh, high-temperature environments.

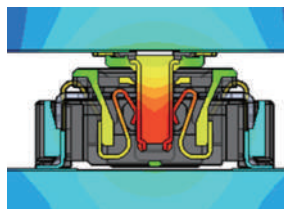

Feature 2 High Speed

IRISO's high-speed transmission products are optimally designed through an organic combination of numerous practical evaluations and simulations. Based on the common plug, the lineup includes products that combine floating technology and high-speed transmission through the integration of high reliability and ease of handling and transmission speeds of up to 10 Gbps.



10126S : Floating Type

11007S : Non Floating Type

10126B : Common Plug

8.0Gbps

10Gbps +

Feature 3 Smallest class

Miniaturization is an inevitable issue for connecting components. However, as devices continue to get smaller, they are becoming more sophisticated and the amount of information they contain continues to increase. IRISO's 0.4 mm PitchBtoB® lineup also includes the 10136 series, which is smaller in size according to the application.

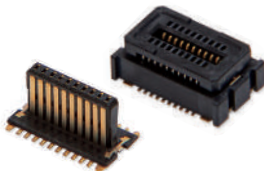

■ Combination and board-to-board distance, selectable number of pins The board-to-board distances for each socket and plug combination are as follows.

Board-to-board distance matrix	10126S/11007S			10136S	11010S
10126B	3mm	3.5mm	4mm	—	—
10136B	—	—	—	3.5mm	—
11010B	—	—	—	—	2mm

Board to Board Connectors

10126B - 10126S

Floating High speed High Temp 0.4 Pitch

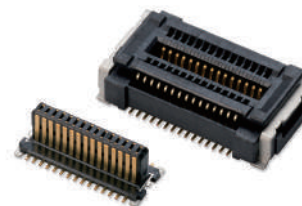

Pitch (mm)	0.4
Mating direction (ST/RA)	ST
Pins	20~60
X/Y-Axis Floating Range (mm)	0.4
Rated voltage (V (AC/DC))	50
Rated current (A)	0.4
Transmission characteristics (Gbps)	MAX8
Operating temperature range (°C)	-40~125

10126B - 11007S

High speed High Temp 0.4 Pitch

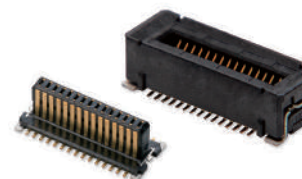

Pitch (mm)	0.4
Mating direction (ST/RA)	ST
Pins	20~60
X/Y-Axis Floating Range (mm)	0
Rated voltage (V (AC/DC))	50
Rated current (A)	0.4
Transmission characteristics (Gbps)	MAX10
Operating temperature range (°C)	-40~125

10136B - 10136S

Floating High speed High Temp 0.4 Pitch

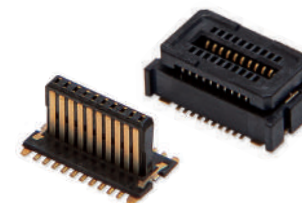

Pitch (mm)	0.4
Mating direction (ST/RA)	ST
Pins	20~
X/Y-Axis Floating Range (mm)	0.4
Rated voltage (V (AC/DC))	50
Rated current (A)	0.4
Transmission characteristics (Gbps)	MAX8
Operating temperature range (°C)	-40~105

11010B - 11010S

High speed High Temp 0.4 Pitch

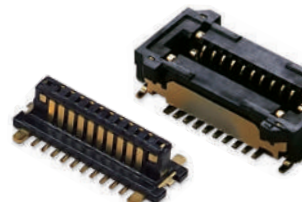

Pitch (mm)	0.4
Mating direction (ST/RA)	ST
Pins	20~60
X/Y-Axis Floating Range (mm)	—
Rated voltage (V (AC/DC))	50
Rated current (A)	0.4
Transmission characteristics (Gbps)	—
Operating temperature range (°C)	-40~125

0.5mm Pitch Floating Connectors ... Board to Board Connectors

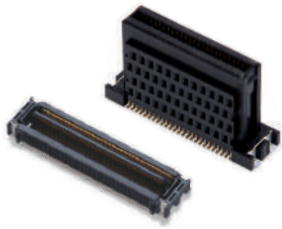

0.5mm pitch, floating type BtoB® connector for high-speed transmission of digital signals. Floating structure allows 0.5mm movement in X-Y direction and 0.5mm effective mating length. The lineup also supports board-to-board distances of 20mm to 30mm, with sockets with a large range of motion over the pitch and vertically movable sockets for right-angle connections. Supports high-speed transmission of 1.0Gbps plus (typical reference value based on in-house definition) (impedance matching: differential 100 ohm) and employs two-point contact for reliable removal of foreign matter even in tough environments.

Feature 1 Floating

Floating type BtoB® connectors move in the X/Y direction to absorb misalignment between boards, facilitating alignment adjustment when making multiple connections and relieving stress concentrated in the solder joint. It also contributes significantly to improving mating performance in conjunction with proper guiding.

Feature 2 High Speed

The increasing sophistication of recent devices and the growing volume of information are spurring demand for high-speed transmission in connecting components. The increase in the high-frequency component of the signal also brings about a situation in which one must pay attention to minute details that were not a problem in the past. IRISO's high-speed transmission products are optimally designed through an organic combination of numerous practical evaluations and simulations. Another key feature is the combination of high reliability and ease of handling through the integration of floating technology and high-speed transmission.

Feature 3 Two-Point Contact

The two-point contact offered by IRISO provides a secure connection even in environments that are prone to dust and dirt by reliably removing foreign matter at the front contact, and can be used with confidence for devices that require high connection reliability. It provides a reliable connection even in harsh environments and can be used with confidence for devices that require high connection reliability.

Before mating

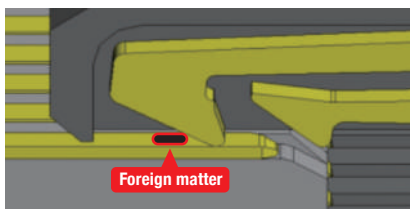

After mating

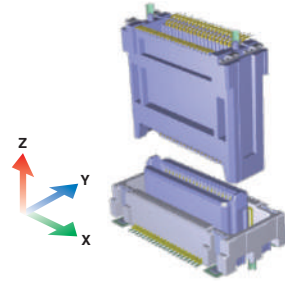
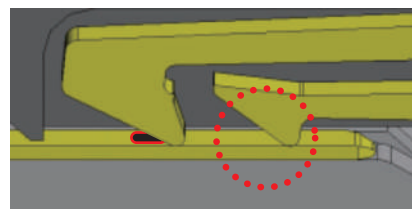

0.5mm Pitch Floating Connectors ... Board to Board Connectors

9984/9985 series (basic type)

The series is based on vertical connection with two-point contact and includes an option for vertical connection with mating compatibility such as high-speed transmission (bellows single point of contact), as well as options such as low insertion/extraction force single point contact (for vertical connection) to support a wide range of basic board-to-board connections.

Normal type (105/125°C)

Board-to-board distance matrix	9984B	
9984S	8mm	9mm
	10mm	11mm
	12mm	13mm
	14mm	15mm
	18mm	19mm

*18mm / 19mm is only 125°C type

Main Features of Basic Products

- 0.5mm motion range each in board plane direction and X-Y axis / movable on plug side
- Absorbs misalignment during assembly and reduces stress on the mounting area. •Ideal for automatic assembly (Automation Connector)
- Effective mating length range of 1mm (±0.5) to support intermediate distances

High connection reliability is achieved with two-point contact that are resistant to foreign matter (with some optional exceptions)

- Front-end contacts reliably remove foreign matter •Redundant connections ensured

Wide range of pin counts (selectable number of pins depends on connection type)

- Variation from 40 to 160 pins in 20-pin increments

Options for high-speed transmission are also available

- Bellows single-point contact option available for high-speed transmission (multi-pin only)
- Supports high-speed transmission up to 5Gbps by combination (differential 100 ohm)

Right-angle socket 9985S series for vertical connections

- Two-point contact for high reliability and one-point contact for low insertion/extraction force

High Speed Transmission type

Board-to-board distance matrix	9984B	
10121S	7mm	8mm
	10mm	11mm
	15mm	16mm

10106/10141 series (Large range of motion)

This is a highly reliable board-to-board connector with two-point contact that can accommodate board-to-board distances of 20mm to 30mm and has a large range of motion over the pitch.

Board-to-board distance matrix	10106S	10141S
Floating Range	X-Y 0.8mm	X-Y 1.2mm
10106B	20mm	
	30mm	

In addition to the features of the basic product, a large range of motion over the pitch absorbs misalignment and improves ease of assembly.

- Large 0.8mm (10106S) range of motion in board plane direction and X-Y axis respectively / movable on socket side
 - 120-pin / 140-pin product with large range of motion (1.2mm), the 10141S, is also available
 - Three board-to-board distances (20/25/30 mm) are available by plug selection. •Lineup from 40 to 140 pins in 20-pin increments
 - Nickel barrier design is used for terminal plating on all products in the series
- (The number of selectable pins varies depending on the connection type)

10112 series (High-speed right angle)

This is a board-to-board connector specially designed for vertical connections, consisting of a vertical movable socket connector and a right-angle plug connector. The 0.5mm narrow pitch achieves high mounting density and supports high-speed transmission.

In addition to the features of the basic product, optimized shape by special design for vertical connection

- Available on 10-140pin
- 0.5 x 0.5 mm range of motion in X (pinout direction) - Y (depth direction) axes, respectively, in the plane of the board on the socket side / movable on the socket side
- 100 ohm differential transmission supported (Please consult us for other requirements)
- 10112B/S Available on 3Gbps high speed transmission
- 9984B/10146S Available on 5Gbps high speed transmission

Number of poles by product	10~30	40~60	70~140
10112B/S	○	○	×
9984B/10146S	×	○	○

Board to Board Connectors

9985S

Floating 0.5 Pitch



Pitch (mm)	0.5
Mating direction (ST/RA)	RA
Pins	40~140
X/Y-Axis Floating Range (mm)	0.5
Rated voltage (V (AC/DC))	50
Rated current (A)	0.4
Transmission characteristics (Gbps)	—
Operating temperature range (°C)	-40~105

9984S

Floating 2-point contact 0.5 Pitch



Pitch (mm)	0.5
Mating direction (ST/RA)	ST
Pins	40~140
X/Y-Axis Floating Range (mm)	0.5
Rated voltage (V (AC/DC))	50
Rated current (A)	0.4
Transmission characteristics (Gbps)	—
Operating temperature range (°C)	-40~125

9984B

Floating 2-point contact 0.5 Pitch



Pitch (mm)	0.5
Mating direction (ST/RA)	ST
Pins	40~160
X/Y-Axis Floating Range (mm)	0.5
Rated voltage (V (AC/DC))	50
Rated current (A)	0.4
Transmission characteristics (Gbps)	—
Operating temperature range (°C)	-40~125

10121S

Floating High speed 0.5 Pitch



Pitch (mm)	0.5
Mating direction (ST/RA)	ST
Pins	100/120/160
X/Y-Axis Floating Range (mm)	0.5
Rated voltage (V (AC/DC))	50
Rated current (A)	0.4
Transmission characteristics (Gbps)	MAX5.9
Operating temperature range (°C)	-40~105

Board to Board Connectors

10112S

Floating High speed 0.5 Pitch



Pitch (mm)	0.5
Mating direction (ST/RA)	ST
Pins	10~60
X/Y-Axis Floating Range (mm)	MAX 0.6
Rated voltage (V (AC/DC))	50
Rated current (A)	0.5
Transmission characteristics (Gbps)	MAX7.8
Operating temperature range (°C)	-40~105

10112B

Floating High speed 0.5 Pitch



Pitch (mm)	0.5
Mating direction (ST/RA)	RA
Pins	10~60
X/Y-Axis Floating Range (mm)	MAX 0.6
Rated voltage (V (AC/DC))	50
Rated current (A)	0.5
Transmission characteristics (Gbps)	MAX7.8
Operating temperature range (°C)	-40~105

10106S

Floating 2-point contact 0.5 Pitch



Pitch (mm)	0.5
Mating direction (ST/RA)	ST
Pins	40~140
X/Y-Axis Floating Range (mm)	MAX 1.2
Rated voltage (V (AC/DC))	50
Rated current (A)	0.4
Transmission characteristics (Gbps)	—
Operating temperature range (°C)	-40~105

10141S

Floating 2-point contact 0.5 Pitch



Pitch (mm)	0.5
Mating direction (ST/RA)	ST
Pins	120/140
X/Y-Axis Floating Range (mm)	1.2
Rated voltage (V (AC/DC))	50
Rated current (A)	0.4
Transmission characteristics (Gbps)	—
Operating temperature range (°C)	-40~105

Board to Board Connectors

10106B Floating 2-point contact 0.5 Pitch

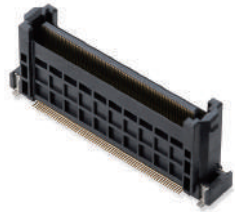

Pitch (mm)	0.5
Mating direction (ST/RA)	ST
Pins	40~140
X/Y-Axis Floating Range (mm)	MAX 1.2
Rated voltage (V (AC/DC))	50
Rated current (A)	0.4
Transmission characteristics (Gbps)	—
Operating temperature range (°C)	-40~105

0.635mm Pitch Floating Connectors ... Board to Board Connectors



The product pitch is half of inch pitch to accommodate various board-to-board distances and to enable use in a wide range of devices, contributing to miniaturization. The two-point contact connection ensures reliable contact in equipment where contact reliability is important. Right angles are also available to expand design flexibility.

Feature 1 Floating

Floating type BtoB® connectors move in the X/Y direction to absorb misalignment between boards, facilitating alignment adjustment when making multiple connections and relieving stress concentrated in the solder joint. It also contributes significantly to improving mating performance in conjunction with proper guiding.

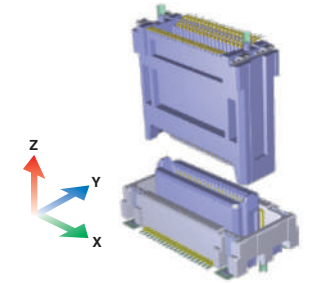

Feature 2 High Speed

The increasing sophistication of recent devices and the growing volume of information are spurring demand for high-speed transmission in connecting components. The increase in the high-frequency component of the signal also brings about a situation in which one must pay attention to minute details that were not a problem in the past. IRISO's high-speed transmission products are optimally designed through an organic combination of numerous practical evaluations and simulations. Another key feature is the combination of high reliability and ease of handling through the integration of floating technology and high-speed transmission.



Feature 3 Two-Point Contact

The two-point contact offered by IRISO provides a secure connection even in environments that are prone to dust and dirt by reliably removing foreign matter at the front contact, and can be used with confidence for devices that require high connection reliability.

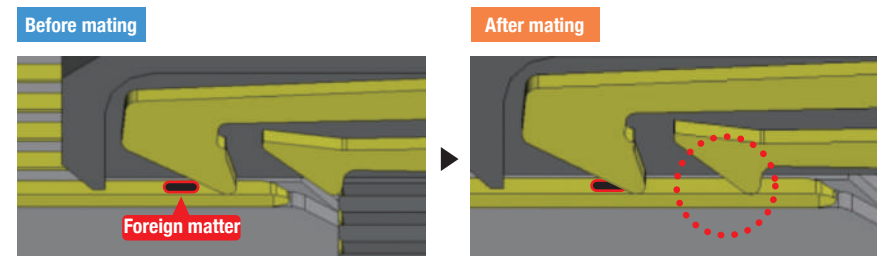

0.635mm Pitch Floating Connectors ... Board to Board Connectors

Key Features of the Group's Products

0.5mm motion range each in board plane direction and X-Y axis / movable on plug side
 •Absorbs misalignment during assembly and reduces stress on the mounting area •Ideal for automatic assembly (connector for robotic assembly)

High connection reliability is achieved with two-point contact that are resistant to foreign matter
 •Front-end contacts reliably remove foreign matter •Redundant connections ensured

Supports high-speed transmission
 Combinations suitable for high-speed transmission within similar board-to-board distances are available
 •Supports high-speed transmission up to 5.7Gbps by combination (differential 100 ohm)

Wide range of board-to-board distances, pin count variations, and a variety of optional specifications
 •Supports from 20 to 120 pins
 •Seamless support for board-to-board distances from 6.5mm to 30.55mm with more than 30 variations
 •Mounting height of each connector can be selected even for the same distance between boards (limited to certain combinations)

Contributes to the use of common board layouts for multiple products due to board-mount compatibility
 (Some types may vary)

Board-to-board distance matrix	10109S				
10109B	6.50mm	8.50mm	9.50mm	14.50mm	16.55mm
	8.50mm	10.00mm	11.00mm	16.00mm	18.05mm
	10.50mm	12.00mm	13.00mm	18.00mm	20.05mm
	12.50mm	14.00mm	15.00mm	20.00mm	22.05mm
	13.00mm	14.50mm	15.50mm	20.50mm	22.55mm
	16.50mm	18.00mm	19.00mm	24.00mm	26.05mm
	18.50mm	20.00mm	21.00mm	26.00mm	28.05mm
	21.00mm	22.50mm	23.50mm	28.50mm	30.55mm

*This product is available in a variety of combinations. See the website (Floating Connector Selection Guide) for more information.

Board to Board Connectors

10109S Floating 2-point contact High speed 0.635 Pitch



Pitch (mm)	0.635
Mating direction (ST/RA)	ST
Pins	20~120
X/Y-Axis Floating Range (mm)	0.5
Rated voltage (V (AC/DC))	50
Rated current (A)	0.5
Transmission characteristics (Gbps)	MAX 5.7
Operating temperature range (°C)	-40~105

10109B Floating 2-point contact High speed 0.635 Pitch



Pitch (mm)	0.635
Mating direction (ST/RA)	ST
Pins	20~120
X/Y-Axis Floating Range (mm)	0.5
Rated voltage (V (AC/DC))	50
Rated current (A)	0.5
Transmission characteristics (Gbps)	MAX 5.7
Operating temperature range (°C)	-40~105

10110B Floating 2-point contact High speed 0.635 Pitch

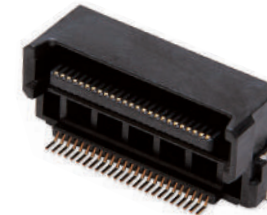

Pitch (mm)	0.635
Mating direction (ST/RA)	RA
Pins	30~120
X/Y-Axis Floating Range (mm)	0.5
Rated voltage (V (AC/DC))	50
Rated current (A)	0.5
Transmission characteristics (Gbps)	MAX6
Operating temperature range (°C)	-40~105

0.8mm Pitch Floating Connectors ... Board to Board Connectors

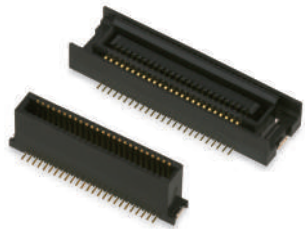

Floating connectors supporting wide board-to-board distance connections with easy-to-use 0.8mm pitch size. 0.5mm motion range on X-Y axis respectively / movable on socket side. High-speed transmission from 900M up to 5.0Gbps (differential 100 ohm) is supported by combination. 9828B right-angle plugs are available, and vertical connection is also supported by combination with 9828S socket connectors.

Feature 1 Floating

Floating type BtoB® connectors move in the X/Y direction to absorb misalignment between boards, facilitating alignment adjustment when making multiple connections and relieving stress concentrated in the solder joint. It also contributes significantly to improving mating performance in conjunction with proper guiding.

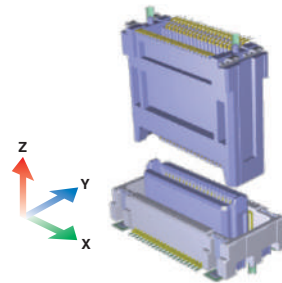

Feature 2 High Speed

The increasing sophistication of recent devices and the growing volume of information are spurring demand for high-speed transmission in connecting components. The increase in the high-frequency component of the signal also brings about a situation in which one must pay attention to minute details that were not a problem in the past. IRISO's high-speed transmission products are optimally designed through an organic combination of numerous practical evaluations and simulations. Another key feature is the combination of high reliability and ease of handling through the integration of floating technology and high-speed transmission.



Feature 3 Lineup

A wide lineup of combinations is offered through mating interchangeability within the series (the number of pin supported will vary depending on the combination)

- Supports connections from 30 to 100 pins in 10-pin increments
- Covers a wide range of board-to-board distances from 6.0mm to 24.7mm

Board-to-board distance matrix	9828B			10102B	9860B				
9827S	6.00mm	8.00mm	9.00mm	8.95mm	12.70mm	14.25mm	15.75mm	17.00mm	20.95mm
9828S	9.75mm	11.75mm	12.75mm	12.70mm	16.45mm	18.00mm	19.50mm	20.75mm	24.70mm
10102S	9.75mm	11.75mm	12.75mm	12.70mm	16.45mm	18.00mm	19.50mm	20.75mm	24.70mm

*This product is available in a variety of combinations. See the website (Floating Connector Selection Guide) for more information.

Board to Board Connectors

9828B

Floating High speed 0.8 Pitch



Pitch (mm)	0.8
Mating direction (ST/RA)	RA
Pins	30~90
X/Y-Axis Floating Range (mm)	0.5
Rated voltage (V (AC/DC))	50
Rated current (A)	0.5
Transmission characteristics (Gbps)	MAX5.4
Operating temperature range (°C)	-40~105

9827B

Floating High speed 0.8 Pitch



Pitch (mm)	0.8
Mating direction (ST/RA)	ST
Pins	30~100
X/Y-Axis Floating Range (mm)	0.5
Rated voltage (V (AC/DC))	50
Rated current (A)	0.5
Transmission characteristics (Gbps)	MAX5
Operating temperature range (°C)	-40~105

10102B

Floating 0.8 Pitch

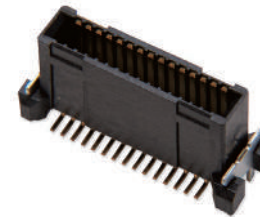

Pitch (mm)	0.8
Mating direction (ST/RA)	ST
Pins	30
X/Y-Axis Floating Range (mm)	0.5
Rated voltage (V (AC/DC))	50
Rated current (A)	0.5
Transmission characteristics (Gbps)	—
Operating temperature range (°C)	-40~105

9860B

Floating High speed 0.8 Pitch



Pitch (mm)	0.8
Mating direction (ST/RA)	ST
Pins	30~100
X/Y-Axis Floating Range (mm)	0.5
Rated voltage (V (AC/DC))	50
Rated current (A)	0.5
Transmission characteristics (Gbps)	MAX1.7
Operating temperature range (°C)	-40~105

Board to Board Connectors

9827S

Floating

0.8 Pitch



Pitch (mm)	0.8
Mating direction (ST/RA)	ST
Pins	30~80
X/Y-Axis Floating Range (mm)	0.5
Rated voltage (V (AC/DC))	50
Rated current (A)	0.5
Transmission characteristics (Gbps)	—
Operating temperature range (°C)	-40~105

9828S

Floating

0.8 Pitch



Pitch (mm)	0.8
Mating direction (ST/RA)	ST
Pins	30~100
X/Y-Axis Floating Range (mm)	0.5
Rated voltage (V (AC/DC))	50
Rated current (A)	0.5
Transmission characteristics (Gbps)	—
Operating temperature range (°C)	-40~105

10102S

Floating

0.8 Pitch



Pitch (mm)	0.8
Mating direction (ST/RA)	ST
Pins	30
X/Y-Axis Floating Range (mm)	0.5
Rated voltage (V (AC/DC))	50
Rated current (A)	0.5
Transmission characteristics (Gbps)	—
Operating temperature range (°C)	-40~105

1.0mm Pitch Floating Connectors ... Board to Board Connectors



1.0mm pitch movable BtoB® connectors with mating compatibility among the series, which enables a diverse lineup. 0.5mm motion range each in board plane direction and X-Y axis / movable on plug side. The design that achieves mating compatibility with six different series allows for a variety of options within each series, such as the number of pins, fixing bosses, board mounting method, plating type. Right-angle plug 9850B series for vertical connection is also available. There is a wide selection of board-to-board distances when vertical in combination alignment.

Feature 1 Floating

Floating type BtoB® connectors move in the X/Y direction to absorb misalignment between boards, facilitating alignment adjustment when making multiple connections and relieving stress concentrated in the solder joint. It also contributes significantly to improving mating performance in conjunction with proper guiding.

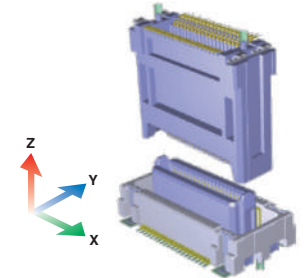

Feature 2 Lineup

Wide range of board-to-board distance variations (number of pins supported varies depending on the combination)

- Supports board-to-board distances from 5.5mm to 19.65mm
- 13 variations from 6 to 30 pins in 2-pin increments

Board-to-board distance matrix	9851B	9853B	9855B	9854B	9856B
9851S	5.50mm	—	10.50mm	—	12.00mm
9855S	6.00mm	—	11.00mm	—	12.50mm
9850S	6.65mm	8.00mm	11.65mm	12.50mm	13.15mm
9852S	8.15mm	9.50mm	13.15mm	14.00mm	14.65mm
9854S	9.65mm	11.00mm	14.65mm	15.50mm	16.15mm
9856S	13.15mm	14.50mm	18.15mm	19.00mm	19.65mm

Board to Board Connectors

9853S

Floating

1.0 Pitch



Pitch (mm)	1.0
Mating direction (ST/RA)	RA
Pins	6~28
X/Y-Axis Floating Range (mm)	0.5/0.8
Rated voltage (V (AC/DC))	125
Rated current (A)	1
Transmission characteristics (Gbps)	—
Operating temperature range (°C)	-40~105

9850B

Floating

1.0 Pitch



Pitch (mm)	1.0
Mating direction (ST/RA)	RA
Pins	6~30
X/Y-Axis Floating Range (mm)	0.5/0.8
Rated voltage (V (AC/DC))	125
Rated current (A)	1
Transmission characteristics (Gbps)	—
Operating temperature range (°C)	-40~105

9851B

Floating

1.0 Pitch

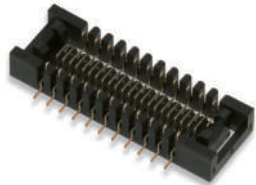

Pitch (mm)	1.0
Mating direction (ST/RA)	ST
Pins	6~30
X/Y-Axis Floating Range (mm)	0.5
Rated voltage (V (AC/DC))	125
Rated current (A)	1
Transmission characteristics (Gbps)	—
Operating temperature range (°C)	-40~105

9853B

Floating

1.0 Pitch

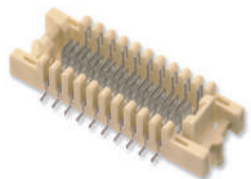

Pitch (mm)	1.0
Mating direction (ST/RA)	ST
Pins	6~30
X/Y-Axis Floating Range (mm)	0.5
Rated voltage (V (AC/DC))	125
Rated current (A)	1
Transmission characteristics (Gbps)	—
Operating temperature range (°C)	-40~105

Board to Board Connectors

9854B

Floating

1.0 Pitch

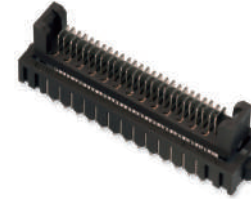

Pitch (mm)	1.0
Mating direction (ST/RA)	ST
Pins	6~30
X/Y-Axis Floating Range (mm)	0.5
Rated voltage (V (AC/DC))	125
Rated current (A)	1
Transmission characteristics (Gbps)	—
Operating temperature range (°C)	-40~105

9855B

Floating

1.0 Pitch



Pitch (mm)	1.0
Mating direction (ST/RA)	ST
Pins	6~30
X/Y-Axis Floating Range (mm)	0.5
Rated voltage (V (AC/DC))	125
Rated current (A)	1
Transmission characteristics (Gbps)	—
Operating temperature range (°C)	-40~105

9856B

Floating

1.0 Pitch



Pitch (mm)	1.0
Mating direction (ST/RA)	ST
Pins	6~30
X/Y-Axis Floating Range (mm)	0.5
Rated voltage (V (AC/DC))	125
Rated current (A)	1
Transmission characteristics (Gbps)	—
Operating temperature range (°C)	-40~105

9850S

Floating

1.0 Pitch



Pitch (mm)	1.0
Mating direction (ST/RA)	ST
Pins	6~30
X/Y-Axis Floating Range (mm)	0.5
Rated voltage (V (AC/DC))	125
Rated current (A)	1
Transmission characteristics (Gbps)	—
Operating temperature range (°C)	-40~105

Board to Board Connectors

9851S

Floating

1.0 Pitch



Pitch (mm)	1.0
Mating direction (ST/RA)	ST
Pins	6~30
X/Y-Axis Floating Range (mm)	0.5
Rated voltage (V (AC/DC))	125
Rated current (A)	1
Transmission characteristics (Gbps)	—
Operating temperature range (°C)	-40~105

9852S

Floating

1.0 Pitch



Pitch (mm)	1.0
Mating direction (ST/RA)	ST
Pins	6~30
X/Y-Axis Floating Range (mm)	0.5
Rated voltage (V (AC/DC))	125
Rated current (A)	1
Transmission characteristics (Gbps)	—
Operating temperature range (°C)	-40~105

9854S

Floating

1.0 Pitch

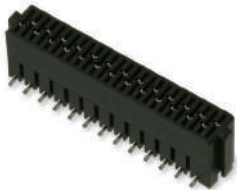

Pitch (mm)	1.0
Mating direction (ST/RA)	ST
Pins	6~30
X/Y-Axis Floating Range (mm)	0.5
Rated voltage (V (AC/DC))	125
Rated current (A)	1
Transmission characteristics (Gbps)	—
Operating temperature range (°C)	-40~105

9855S

Floating

1.0 Pitch

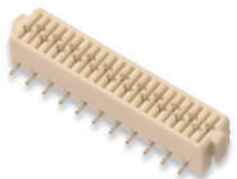

Pitch (mm)	1.0
Mating direction (ST/RA)	ST
Pins	6~28
X/Y-Axis Floating Range (mm)	0.5
Rated voltage (V (AC/DC))	125
Rated current (A)	1
Transmission characteristics (Gbps)	—
Operating temperature range (°C)	-40~105

Board to Board Connectors

9856S

Floating

1.0 Pitch



Pitch (mm)	1.0
Mating direction (ST/RA)	ST
Pins	8~30
X/Y-Axis Floating Range (mm)	0.5
Rated voltage (V (AC/DC))	125
Rated current (A)	1
Transmission characteristics (Gbps)	—
Operating temperature range (°C)	-40~105

2.0mm Pitch Board to Board Connectors



Board-to-board connectors with a 2.0mm pitch. Guide posts ensure a smooth fitting. Groove structure prevents improper insertion and twisting. Structure with three-sided walls to guide insertion. Horizontal connection (ST/ST) and vertical connection (ST/RA) types available. The 9111 series is a compact type for dual-row installation. The 9115 series has a mating lock function for a secure connection. Various types are available according to the usage purpose.

9110B - 9110S

2.00 Pitch



Pitch (mm)	2.0
Mating direction (ST/RA)	9110B ST 9110S ST/RA
Pins	2~20
Rated voltage (V (AC/DC))	125
Rated current (A)	1
Transmission characteristics (Gbps)	—
Operating temperature range (°C)	-40~105

9111B - 9111S

2.00 Pitch



Pitch (mm)	2.0
Mating direction (ST/RA)	9111B ST 9111S ST/RA
Pins	6~30
Rated voltage (V (AC/DC))	125
Rated current (A)	1
Transmission characteristics (Gbps)	—
Operating temperature range (°C)	-40~105

9115B - 9115S

2.00 Pitch



Pitch (mm)	2.0
Mating direction (ST/RA)	9115B ST 9115S ST/RA
Pins	3~20
Rated voltage (V (AC/DC))	125
Rated current (A)	1
Transmission characteristics (Gbps)	—
Operating temperature range (°C)	-40~105

High Current Floating Connectors Board to Board Connectors

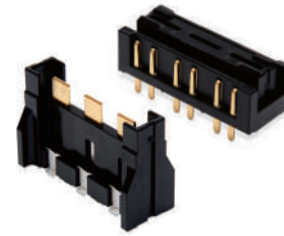

Lineup of compact, high-current-capable, board-to-board connectors with floating functionality for power connection in limited space. The multi-contact structure provides reliable low contact resistance while maintaining motion characteristics. High temperature rating for maximum current carrying capability. (125°C)

300V (pollution degree 2)/15 A/125°C rated: 9880SB series
600V (pollution degree 2)/15A/125°C rated: 10122SB Series

Feature 1 Floating

Floating type BtoB® connectors move in the X/Y direction to absorb misalignment between boards, facilitating alignment adjustment when making multiple connections and relieving stress concentrated in the solder joint. It also contributes significantly to improving mating performance in conjunction with proper guiding.

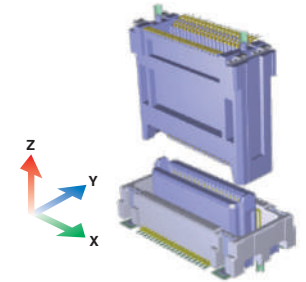

Feature 2 High Temperature

The rising amount of heat generated around engines in in-vehicle equipment and the increasing sophistication of devices have increased the need for connectors to have high heat resistance. These highly heat-resistant products created with our material and design technologies can be used with confidence even in harsh, high-temperature environments.

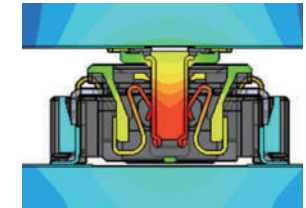

Feature 3 High Power

IRISO's high-current connectors have an independent four-point contact structure that provides high contact reliability and low contact resistance, minimizes heat retention in the connector mating area, and achieves a high upper operating temperature range. IRISO's proprietary floating mechanism adds high current capability to misalignment correction and contributes to improve ease of handling of high current connections at multiple locations.

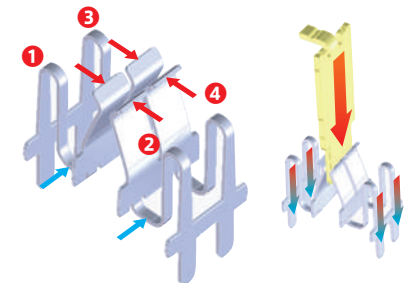

■ Combination and board-to-board distance, selectable number of pins
The board-to-board distances for each socket and plug combination are as follows.

Board-to-board distance matrix	9880B	10122B
9880S	15.0mm	—
10122S	—	30.0mm

Board to Board Connectors

9880B - 9880S

Floating 2-point contact High Temp High Voltage 9.2 Pitch

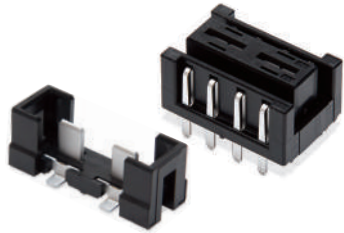

Pitch (mm)	9.2
Mating direction (ST/RA)	ST
Pins	2
X/Y-Axis Floating Range (mm)	1.0
Rated voltage (V (AC/DC))	300
Rated current (A)	15
Transmission characteristics (Gbps)	—
Operating temperature range (°C)	-40~125

10122B - 10122S

Floating 2-point contact High Temp High Voltage 11.0 Pitch

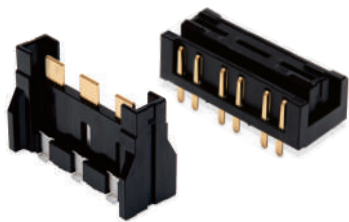

Pitch (mm)	11.0
Mating direction (ST/RA)	ST
Pins	3
X/Y-Axis Floating Range (mm)	1.0
Rated voltage (V (AC/DC))	600
Rated current (A)	15
Transmission characteristics (Gbps)	—
Operating temperature range (°C)	-40~125

Pin header

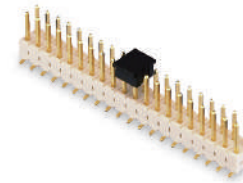

The pin header connector is the 'male' plug of the connector. The male pins are cut and coated with insulation made from resin materials. It is typically used for internal board-to-board connections. Viewed from the side, it looks like a "kenzan," which is a special tool used for flower arrangement. The female side is called the 'socket.' IRISO got its start in pin manufacturing. A wide variety of connections can be made by selecting the pin length, pin diameter, and locking position.

1 History of Connectors

What is the purpose of connectors, and since when have they been needed? The answers are from the Second World War. The demand for munitions created by the war spawned the development of various electronic equipment. Such equipment was used in severe environments. If a malfunction occurred, the whole equipment would need to be taken to a repair factory each time. This was especially difficult for large equipment. Much cost was required, and even if speed was essential, much time and effort was needed. Backups also needed to be of the whole equipment. As a result, there was a strong desire to replace only necessary portions to simplify repair. This led to the concept of changing soldered connections to detachable electrical connections. Connectors were developed for achieving this and began to be implemented. The first type of connector was for making soldered electrical wires detachable. The shape greatly changed over time due to the synergetic effect caused by the spread of printed circuit boards and the invention and development of various electronic parts.



2 Starting from a Single Pin

Pins are the foundation of IRISO. Our pins have a bullet shape (tapered tip) which other companies cannot mimic. The purpose of this shape is to make it easier to fit the contacts into the printed circuit boards. The tips of male terminals for automotive use are tapered, and part of the tapered portion is rounded, allowing for smooth mating and press-fitting when inserted to the opening side (female side, board side). This results in a lower insertion force, which reduces damage to mating contacts. Enlarged image of a "Pin tip" that was manufactured using our unique "C-Type Machine (Square pin conical taper processing machine)" (taken with a scanning electron microscope (SEM) in 1980). Pins manufactured with the C-type machine are processed by forging, tip crushing, and then rotary cutting (roller chuck mechanism). Since no blade is used for cutting, the tip is extremely smooth (bullet processing).



*For existing products, pins are produced using C-type machines and are processed into pin headers (products in the guide)

*All new products (pin header shape) are pressed pins due to quality

Pin header

9210B

2.00 Pitch

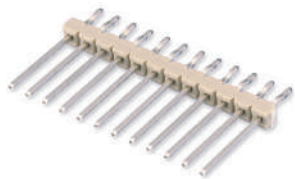

Pitch (mm)	2.0
Mating direction (ST/RA)	ST
Pins	10~34
Rated voltage (V (AC/DC))	125
Rated current (A)	1
Transmission characteristics (Gbps)	—
Operating temperature range (°C)	-40~105

9201B

2.54 Pitch

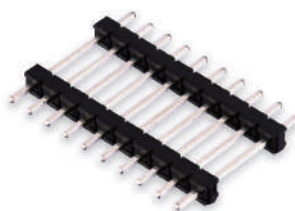

Pitch (mm)	2.54
Mating direction (ST/RA)	ST
Pins	2~32
Rated voltage (V (AC/DC))	250
Rated current (A)	3
Transmission characteristics (Gbps)	—
Operating temperature range (°C)	—

13014B

2.54 Pitch

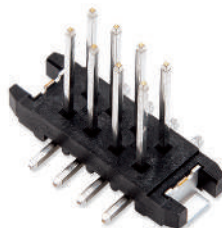

Pitch (mm)	2.54
Mating direction (ST/RA)	RA
Pins	8~12
Rated voltage (V (AC/DC))	250
Rated current (A)	3
Transmission characteristics (Gbps)	—
Operating temperature range (°C)	-40~105

Pin header

9261B

2.54 Pitch

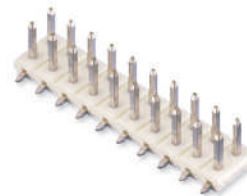

Pitch (mm)	2.54
Mating direction (ST/RA)	ST
Pins	4~14
Rated voltage (V (AC/DC))	250
Rated current (A)	3
Transmission characteristics (Gbps)	—
Operating temperature range (°C)	-40~105

9203B

2.54 Pitch



Pitch (mm)	2.54
Mating direction (ST/RA)	RA
Pins	2~10
Rated voltage (V (AC/DC))	250
Rated current (A)	3
Transmission characteristics (Gbps)	—
Operating temperature range (°C)	-40~105

Device Socket (Power Module Connection)



The Z-Move™ structure socket for power modules (Pitch: 2.54 mm, 0.64 mm, compatible with square pins) uses the bottom mating method, ideal for PCB stacks, and replaces conventional hand-soldered board connections with connectors. This eliminates the need for time-consuming soldering while improving connection reliability.

Feature 1 Bottom Mating Method

Since the bottom mating method (where pins are inserted from the bottom of the connector) is used, which is good for board stacking, the insertion status of pins can be confirmed visually.

Feature 2 Floating Structure and Position Shift Correction

The IRISO floating connector moves in the X/Y direction. Since it absorbs the position deviation between the boards during mating, it is easy to design multiple arrays on the same board, contributing to improved workability. In addition, this series adopts a unique "Z-Move™ structure*1" to realize floating in the Z direction. It absorbs board resonance after mating and demonstrates high connection reliability.

*1 Z-Move is a registered trademark of IRISO ELECTRONICS CO.,LTD.

Feature 3 Less Stress on Soldered Areas

In addition to the floating structure, there are metal flanges at both ends of the housing, which reduces the stress on soldered areas caused by external force, and prevents soldering cracks.

Supplemental Information What is the Z-Move™ Structure?

Movement in the Z-axis is possible while contact points remain fixed. This connector has excellent resistance to vibration and shocks. Relieves stress on solder joints due to vibration, resonance, and shocks. It greatly improves ease of handling and reliability.

*P23: Refer to the BtoB™ connector for board-to-board connection with the Z-Move™ structure.

*Contact our Sales Department for more information on recommended mating terminal sizes.

*Pin assignment and fixing bracket positions can be customized. Contact our Sales Department for more information.

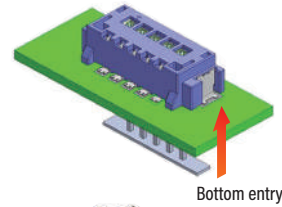

Bottom entry

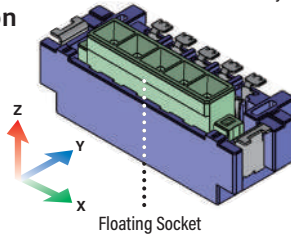

Floating Socket

Power Module

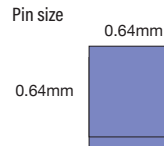

Pin size

0.64mm

0.64mm

18021S

Z-Move™

High Temp

2.54 Pitch

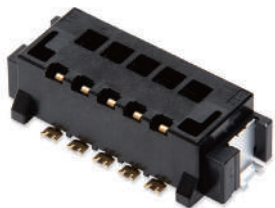

Pitch (mm)	2.54
Mating direction (ST/RA)	ST
Pins	3~10
X/Y-Axis Floating Range (mm)	0.5
Rated voltage (V (AC/DC))	125
Rated current (A)	1
Transmission characteristics (Gbps)	—
Operating temperature range (°C)	-40~125

Device Socket (LCD Connection)

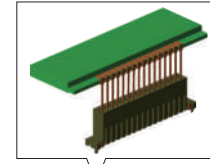

LCD Socket

0.5mm

0.3mm

Two types of connection directions, Top entry and Bottom entry, are available to accommodate various types of LCDs. SMT supports automatic mounting and reduces the soldering process for tabs. Supports tabs of 0.5 mm wide x 0.3 mm thick for connection with 5 P to 30 P expansion.

*Connected LCD devices are limited to 2.0 mm pitch.

*Contact our Sales Department for more information on recommended mating terminal sizes.

9242S

2.00 Pitch

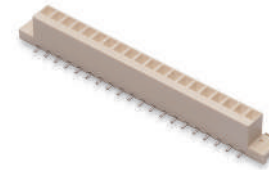

Pitch (mm)	2.00
Mating direction (ST/RA)	ST
Pins	5~28
Rated voltage (V (AC/DC))	125
Rated current (A)	1
Transmission characteristics (Gbps)	—
Operating temperature range (°C)	-40~105

9240S

2.00 Pitch



Pitch (mm)	2.00
Mating direction (ST/RA)	ST
Pins	6~22
Rated voltage (V (AC/DC))	125
Rated current (A)	1
Transmission characteristics (Gbps)	—
Operating temperature range (°C)	-40~105

9257S

2.00 Pitch

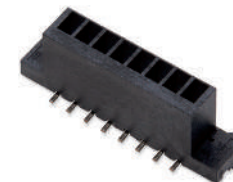

Pitch (mm)	2.00
Mating direction (ST/RA)	ST
Pins	6~30
Rated voltage (V (AC/DC))	125
Rated current (A)	1
Transmission characteristics (Gbps)	—
Operating temperature range (°C)	-40~105

Wire Harness Connectors



2.0mm pitch connector for unsealed in-vehicle equipment interface. 050 terminals (ultra-compact crimp terminals with box structure) are used to achieve miniaturization, low profile, and high density. Designed for high operating temperatures up to +125°C and SMT specifications for automatic mounting. Single-row/ two-row types are available.

Feature 1 Space saving

0.5mm terminal has been adopted instead of the conventional 0.64mm terminal. Compared to our 9491 series that uses 0.64mm terminals (2.2mm pitch), this series is 59% smaller in terms of board area and 60% smaller in terms of board-side connector height.



Feature 2 High Temperature

The rising amount of heat generated around engines in in-vehicle equipment and the increasing sophistication of devices have increased the need for connectors to have high heat resistance. These highly heat-resistant products created with our material and design technologies can be used with confidence even in harsh, high-temperature environments.

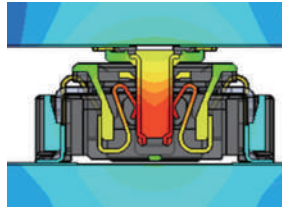

Feature 3 Usability improvement

The space is provided to make it easier to hold the connector during connector insertion and extraction operation. A bridge surrounds the top of the locking lever to prevent deformation that occurs when the cable harness is bundled. In addition, three types of keying are used to prevent incorrect mating.

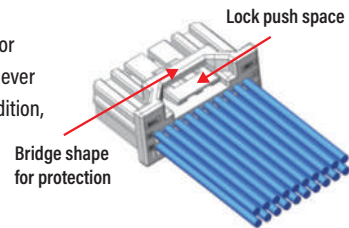

Single-row type

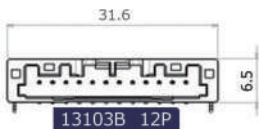

Two-row type

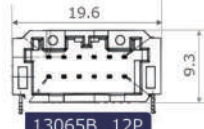

Comparison of board-side connector size (in mm) *The following numbers of pins will be added in the future. Please contact our sales representative for details.

Series	Height	Depth	Mated size	Number of pins and width dimensions										
				2P	4P	8P	10P	12P	16P	20P	24P	28P	32P	40P
13103B	6.5	18.2	22.1	11.6	15.6	23.6	27.6	31.6	39.6	47.6	—	—	—	—
13065B	9.3			—	—	15.6	—	19.6	23.6	27.4	31.6	35.6	39.6	47.6

Wire Harness Connectors

13103B - 13103S

High Temp

2.0 Pitch

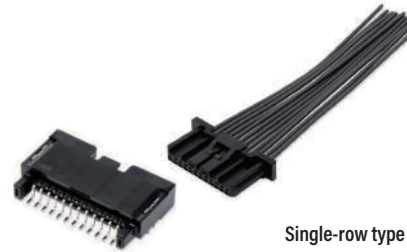

Single-row type

Pitch (mm)	2.0
Mating direction (ST/RA)	RA
Product height (mm)	6.50
Pins	2~20
Rated voltage (V (AC/DC))	50
Rated current (A)	3
Transmission characteristics (Gbps)	—
Operating temperature range (°C)	-40~125

13065B - 13065S

High Temp

2.0 Pitch



Two-row type

Pitch (mm)	2.0
Mating direction (ST/RA)	RA
Product height (mm)	9.30
Pins	8~40
Rated voltage (V (AC/DC))	50
Rated current (A)	3
Transmission characteristics (Gbps)	—
Operating temperature range (°C)	-40~125

FPC/FFC Connectors



IRISO's FPC/FFC connectors are a combination of the ZIF type that can lock FPC/FFC with little force when inserting a card and our proprietary locking method I-Lock™ to prevent a card from falling out. The click sensation upon card insertion improves ease of handling and work quality. A wide range of variations are available, such as the Auto I-Lock™ structure, which combines automatic assembly and high-speed transmission. It can be used in a wide range of applications from automotive electronics to mobile devices and mobile phones. Some of our products also feature a highly reliable two-point contact structure and are designed with an emphasis on high heat resistance, making them suitable for use in harsh high-temperature environments.

*We also have products that are suitable for 125°C. Please contact our sales department.

New FPC/FFC connector Auto I-Lock™ derived from Non-ZIF connector

This is a completely new concept, further developed from I-Lock™, the optional mechanism of the aforementioned ZIF connector, and achieved in combination with a Non-ZIF structure. While retaining the ease of handling that has been an advantage of non-ZIF connectors, these connectors have card retention and perfect insertion perception, making them highly compatible with manual operations as well as with various types of automation, and dramatically reducing problems caused by incomplete insertion.

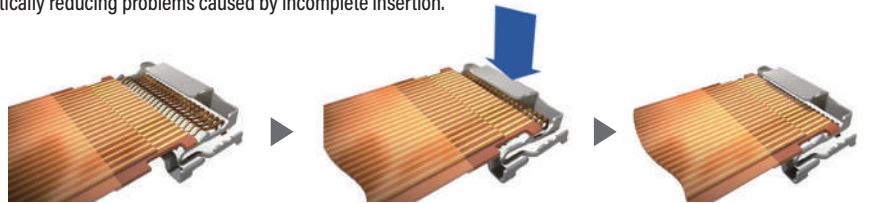

More Advanced Auto I-Lock™

Products with a more advanced version of the existing Auto I-Lock™ aimed for greater automation. An inspection window is installed for monitoring the insertion position after the card is inserted, allowing for image recognition via a camera, etc. The deep slit at the opening for card insertion improves guiding ability. This makes it easier to have auto-insertion using robots.

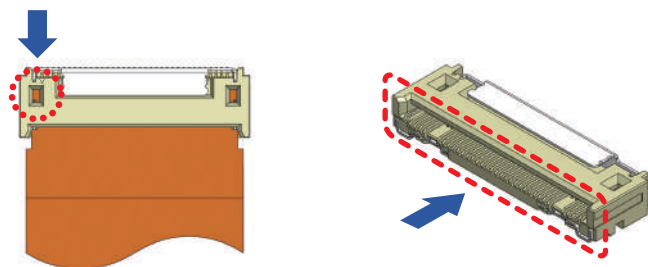

FPC/FFC Connectors

ZIF Connectors

ZIF stands for Zero Insertion Force and refers to a connector for which no force is applied when the FPC/FFC is mated to the connector. On the other hand, the terminals must have contact pressure where the connector mates with the card, and the card must be retained. The ZIF connector has a locking mechanism for this purpose. There are three main types of locking mechanisms, referred to as slider type, front flip type, and back flip type.

► Slider type

After the card is inserted into the connector, the slider is pushed in to hold the card with its terminal and lock the card while maintaining contact pressure and card retention. It is the earliest used of the three locking methods. It has a high card retention capacity.

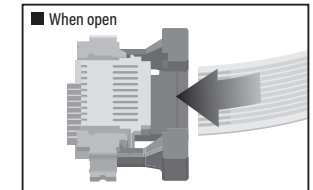

► Front Flip Type

This type has improved ease of handling over the slider type. The cover can be closed to hold down the card.

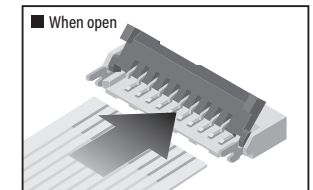

I-Lock™ Connector

► Optional locking I-Lock™ mechanism for ZIF connectors

The figure shows an example of a combined use with the slider type, in which a notch is cut in the plastic part of the card and the holding terminal on the spring is made to go over the notch to provide a temporary holding function.

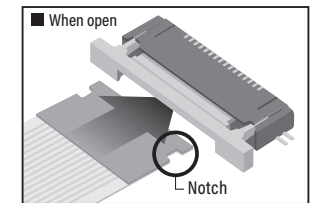

Non-ZIF Connectors

It is a non-ZIF connector, i.e., it is a connector that requires force (insertion force) when mating the card to the connector. This type does not have a locking mechanism, but instead the terminals are arranged to have contact pressure, which allows the connector to hold the card in place. Therefore, it is a type that has advantages in terms of workability and size, and is easy to keep costs down.

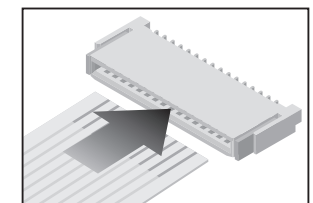

FPC/FFC Connectors

Product Lineup

This is a list of the products we handle by pitch and product height.



Horizontal type (Right-angle type)

Pitch	0.30mm			0.50mm						1.00mm			
	FLIP	FLIP	FLIP/I-Lock™	Bottom	Top	Bottom	Top	Bottom	Top	Bottom	Top	Bottom	
0.90	9671S												
1.80					9631S	9632S	9685S	9686S					
2.00		9637S											
2.50			12001S	12003S					9616S	9617S			
2.55											9663S	9664S	
3.40									11501S				

Vertical type (Straight type)

Pitch	0.50mm			1.00mm	
	ZIF	ZIF/I-Lock™	Auto I-Lock™	ZIF	ZIF/I-Lock™
4.80				9619S	
5.50	9639S	9687S			9665S
6.50			11600S		



How to use the connector type

Locking Structure	Ease of handling	Card insertion force	Card retention capacity	Size	
Auto I-Lock™	 ◎	1 action	△	○	△
ZIF	 ×	2 action	○	◎	△
FLIP	 △	2 action	○	△	○
ZIF/I-Lock™	 ×	2 action	○	◎	△
NON-ZIF	 ○	1 action	×	×	◎

FPC/FFC Connectors

9671S

0.3 Pitch



Pitch (mm)	0.3
Mating direction (ST/RA)	RA
Lock method	FLIP
Point of contact (Top/Bottom/One side contact)	Bottom
Product height (mm)	0.9/3.5(3.8)
Pins	11~51
Rated voltage (V (AC/DC))	50
Rated current (A)	0.2
Transmission characteristics (Gbps)	—
Operating temperature range (°C)	-40~85

12003S

2-point contact

High speed

0.5 Pitch

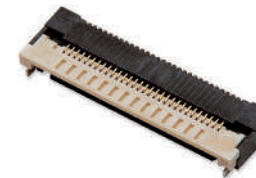

Pitch (mm)	0.5
Mating direction (ST/RA)	RA
Lock method	FLIP
Point of contact (Top/Bottom/One side contact)	Bottom
Product height (mm)	2.5/5.9(6.5)
Pins	10~68
Rated voltage (V (AC/DC))	50
Rated current (A)	0.4
Transmission characteristics (Gbps)	1
Operating temperature range (°C)	-40~105

12001S

2-point contact

0.5 Pitch

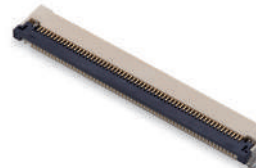

Pitch (mm)	0.5
Mating direction (ST/RA)	RA
Lock method	FLIP
Point of contact (Top/Bottom/One side contact)	Bottom
Product height (mm)	2.5/5.6(6.1)
Pins	6~70
Rated voltage (V (AC/DC))	50
Rated current (A)	0.4
Transmission characteristics (Gbps)	1
Operating temperature range (°C)	-40~105

11600S

High speed

Auto I-Lock™

0.5 Pitch



Pitch (mm)	0.5
Mating direction (ST/RA)	ST
Lock method	Auto I-Lock™
Point of contact (Top/Bottom/One side contact)	One side contact
Product height (mm)	6.5/5.0
Pins	8~60
Rated voltage (V (AC/DC))	50
Rated current (A)	0.5
Transmission characteristics (Gbps)	25
Operating temperature range (°C)	-40~105

FPC/FFC Connectors

11503S

High speed Auto I-Lock™ 0.5 Pitch



Pitch (mm)	0.5
Mating direction (ST/RA)	RA
Lock method	Auto I-Lock™
Point of contact (Top/Bottom/One side contact)	Bottom
Product height (mm)	3.4/6.45
Pins	20~60
Rated voltage (V (AC/DC))	50
Rated current (A)	0.5
Transmission characteristics (Gbps)	25
Operating temperature range (°C)	-40~105

11501S

High speed Auto I-Lock™ 0.5 Pitch



Pitch (mm)	0.5
Mating direction (ST/RA)	RA
Lock method	Auto I-Lock™
Point of contact (Top/Bottom/One side contact)	Bottom
Product height (mm)	3.4/6.85
Pins	8~60
Rated voltage (V (AC/DC))	50
Rated current (A)	0.5
Transmission characteristics (Gbps)	25
Operating temperature range (°C)	-40~105

9687S

I-Lock™ 0.5 Pitch



Pitch (mm)	0.5
Mating direction (ST/RA)	ST
Lock method	ZIF/I-Lock™
Point of contact (Top/Bottom/One side contact)	One side contact
Product height (mm)	5.5/2.5(4.9)
Pins	4~60
Rated voltage (V (AC/DC))	50
Rated current (A)	0.5
Transmission characteristics (Gbps)	—
Operating temperature range (°C)	-40~105

9686S

I-Lock™ 0.5 Pitch



Pitch (mm)	0.5
Mating direction (ST/RA)	RA
Lock method	ZIF/I-Lock™
Point of contact (Top/Bottom/One side contact)	Bottom
Product height (mm)	1.8/4.9(5.6)
Pins	4~50
Rated voltage (V (AC/DC))	50
Rated current (A)	0.5
Transmission characteristics (Gbps)	—
Operating temperature range (°C)	-40~105

FPC/FFC Connectors

9685S

High speed I-Lock™ 0.5 Pitch



Pitch (mm)	0.5
Mating direction (ST/RA)	RA
Lock method	ZIF/I-Lock™
Point of contact (Top/Bottom/One side contact)	Top
Product height (mm)	1.8/4.9(5.6)
Pins	4~50
Rated voltage (V (AC/DC))	50
Rated current (A)	0.5
Transmission characteristics (Gbps)	1.7
Operating temperature range (°C)	-40~105

9639S

0.5 Pitch

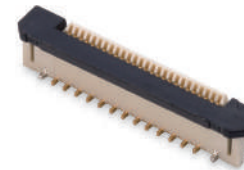

Pitch (mm)	0.5
Mating direction (ST/RA)	ST
Lock method	ZIF
Point of contact (Top/Bottom/One side contact)	One side contact
Product height (mm)	5.5/2.5(4.9)
Pins	6~60
Rated voltage (V (AC/DC))	50
Rated current (A)	0.5
Transmission characteristics (Gbps)	—
Operating temperature range (°C)	-40~105

9637S

High speed 0.5 Pitch



Pitch (mm)	0.5
Mating direction (ST/RA)	RA
Lock method	FLIP
Point of contact (Top/Bottom/One side contact)	Bottom
Product height (mm)	2.0/5.3(6.1)
Pins	6~60
Rated voltage (V (AC/DC))	50
Rated current (A)	0.5
Transmission characteristics (Gbps)	1.7
Operating temperature range (°C)	-40~105

9632S

High speed 0.5 Pitch

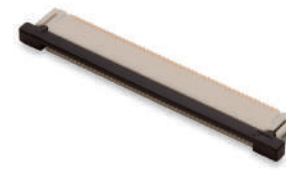

Pitch (mm)	0.5
Mating direction (ST/RA)	RA
Lock method	ZIF
Point of contact (Top/Bottom/One side contact)	Bottom
Product height (mm)	1.8/4.1(4.8)
Pins	4~50
Rated voltage (V (AC/DC))	50
Rated current (A)	0.5
Transmission characteristics (Gbps)	1.7
Operating temperature range (°C)	-40~105

FPC/FFC Connectors

9631S

0.5 Pitch



Pitch (mm)	0.5
Mating direction (ST/RA)	RA
Lock method	ZIF
Point of contact (Top/Bottom/One side contact)	Bottom
Product height (mm)	1.8/4.1 (4.8)
Pins	4~50
Rated voltage (V (AC/DC))	50
Rated current (A)	0.5
Transmission characteristics (Gbps)	—
Operating temperature range (°C)	-40~105

9665S

High Temp

I-Lock™

1.0 Pitch



Pitch (mm)	1.0
Mating direction (ST/RA)	ST
Lock method	ZIF/I-Lock™
Point of contact (Top/Bottom/One side contact)	One side contact
Product height (mm)	5.5/2.5 (4.9)
Pins	4~40
Rated voltage (V (AC/DC))	125
Rated current (A)	1.0
Transmission characteristics (Gbps)	—
Operating temperature range (°C)	-40~125

9664S

I-Lock™

1.0 Pitch



Pitch (mm)	1.0
Mating direction (ST/RA)	RA
Lock method	ZIF/I-Lock™
Point of contact (Top/Bottom/One side contact)	Bottom
Product height (mm)	2.5/6.8 (7.2)
Pins	4~40
Rated voltage (V (AC/DC))	125
Rated current (A)	1.0
Transmission characteristics (Gbps)	—
Operating temperature range (°C)	-40~105

9663S

I-Lock™

1.0 Pitch



Pitch (mm)	1.0
Mating direction (ST/RA)	RA
Lock method	ZIF/I-Lock™
Point of contact (Top/Bottom/One side contact)	Top
Product height (mm)	2.5/6.8 (7.2)
Pins	4~30
Rated voltage (V (AC/DC))	125
Rated current (A)	1.0
Transmission characteristics (Gbps)	—
Operating temperature range (°C)	-40~105

FPC/FFC Connectors

9619S

1.0 Pitch



Pitch (mm)	1.0
Mating direction (ST/RA)	ST
Lock method	ZIF
Point of contact (Top/Bottom/One side contact)	One side contact
Product height (mm)	5.0/3.2 (4.5)
Pins	4~40
Rated voltage (V (AC/DC))	125
Rated current (A)	1.0
Transmission characteristics (Gbps)	—
Operating temperature range (°C)	-40~105

9617S

1.0 Pitch

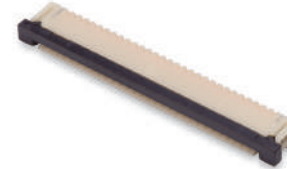

Pitch (mm)	1.0
Mating direction (ST/RA)	RA
Lock method	ZIF
Point of contact (Top/Bottom/One side contact)	Bottom
Product height (mm)	2.5/5.4 (6.9)
Pins	4~40
Rated voltage (V (AC/DC))	125
Rated current (A)	1.0
Transmission characteristics (Gbps)	—
Operating temperature range (°C)	-40~105

9616S

1.0 Pitch

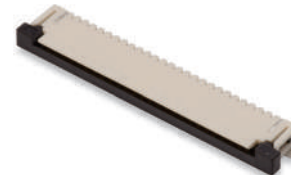

Pitch (mm)	1.0
Mating direction (ST/RA)	RA
Lock method	ZIF
Point of contact (Top/Bottom/One side contact)	Top
Product height (mm)	2.5/5.4 (6.9)
Pins	4~40
Rated voltage (V (AC/DC))	125
Rated current (A)	1.0
Transmission characteristics (Gbps)	—
Operating temperature range (°C)	-40~105

9604S

1.25 Pitch

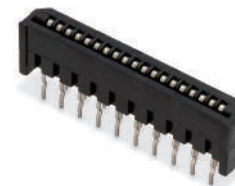

Pitch (mm)	1.25
Mating direction (ST/RA)	ST/RA
Lock method	NON-ZIF
Point of contact (Top/Bottom/One side contact)	Top (RA)
Product height (mm)	ST;7.2/4.2 RA;4.2/7.2
Pins	4~40
Rated voltage (V (AC/DC))	125
Rated current (A)	1.0
Transmission characteristics (Gbps)	—
Operating temperature range (°C)	-40~105

Compression Terminal



The compression terminal is IRISO's direct touch connection terminal that advocates wireless connections. One-piece structure. The terminal's spring-pressured adsorption concept ensures high reliability in insertion/extraction endurance test. More than 40 types from 0.6mm to 70mm with a wide range of height variations. Ideal for internal connection of mobile phones and mobile devices.

Product Lineup

IRISO Series No.	Recommended range of use (mm)
4103T	0.6~1.1
4067T	0.7~0.9
4056T	0.8~1.0
4104T	0.9~1.1
16109T	0.85~1.4
4039T	1.1~1.6
4102T	1.25~1.6
4099T	1.6~2.1
4066T	1.95~2.25
4101T	2.1~2.5
4076T	2.45~2.85
4055T	2.85~3.45
4080T	4.5~6.5
16106T	5.0~6.0
16105T	6.0~7.0

Compression range

The recommended compression range is the range where contact is stable. Recommended products should be selected according to the board-to-board height where they will be mounted. We have a variety of compression ranges from 0.6mm to 70mm.

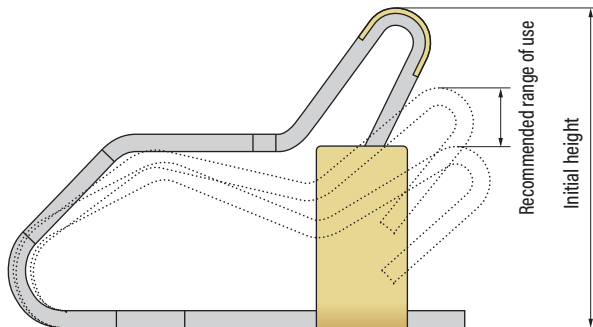

Compression Terminal

4103T



Product height (mm)	1.4
Compression range (mm)	0.6 - 1.1
Rated voltage (V (AC/DC))	50
Rated current (A)	0.5
Transmission characteristics (Gbps)	—
Operating temperature range (°C)	-40~105

4067T



Product height (mm)	3.05
Compression range (mm)	0.7 - 0.9
Rated voltage (V (AC/DC))	—
Rated current (A)	—
Transmission characteristics (Gbps)	—
Operating temperature range (°C)	-40~105

4056T



Product height (mm)	1.25
Compression range (mm)	0.8 - 1.0
Rated voltage (V (AC/DC))	—
Rated current (A)	—
Transmission characteristics (Gbps)	—
Operating temperature range (°C)	-40~105

4104T



Product height (mm)	1.4
Compression range (mm)	0.9 - 1.1
Rated voltage (V (AC/DC))	50
Rated current (A)	1
Transmission characteristics (Gbps)	—
Operating temperature range (°C)	-40~85

Compression Terminal

16109T



Product height (mm)	7.8
Compression range (mm)	0.85 - 1.4
Rated voltage (V (AC/DC))	50
Rated current (A)	1
Transmission characteristics (Gbps)	—
Operating temperature range (°C)	-40~85

4039T



Product height (mm)	1.9
Compression range (mm)	1.1
Rated voltage (V (AC/DC))	—
Rated current (A)	—
Transmission characteristics (Gbps)	—
Operating temperature range (°C)	-40~105

4102T



Product height (mm)	2
Compression range (mm)	1.25 - 1.6
Rated voltage (V (AC/DC))	50
Rated current (A)	1
Transmission characteristics (Gbps)	—
Operating temperature range (°C)	-40~85

4099T



Product height (mm)	2.5
Compression range (mm)	1.6 - 2.1
Rated voltage (V (AC/DC))	125
Rated current (A)	0.5
Transmission characteristics (Gbps)	—
Operating temperature range (°C)	-40~105

Compression Terminal

4066T



Product height (mm)	1.15
Compression range (mm)	1.95 - 2.25
Rated voltage (V (AC/DC))	—
Rated current (A)	—
Transmission characteristics (Gbps)	—
Operating temperature range (°C)	-40~105

4101T



Product height (mm)	2.85
Compression range (mm)	2.1 - 2.5
Rated voltage (V (AC/DC))	50
Rated current (A)	0.5
Transmission characteristics (Gbps)	—
Operating temperature range (°C)	-40~85

4076T



Product height (mm)	3.3
Compression range (mm)	2.45 - 2.85
Rated voltage (V (AC/DC))	50
Rated current (A)	0.5
Transmission characteristics (Gbps)	—
Operating temperature range (°C)	-40~105

4055T



Product height (mm)	4.25
Compression range (mm)	2.85
Rated voltage (V (AC/DC))	—
Rated current (A)	—
Transmission characteristics (Gbps)	—
Operating temperature range (°C)	-40~105

Compression Terminal

4080T



Product height (mm)	7.2
Compression range (mm)	4.5 - 6.5
Rated voltage (V (AC/DC))	125
Rated current (A)	3
Transmission characteristics (Gbps)	—
Operating temperature range (°C)	-40~105

16106T



Product height (mm)	6.8
Compression range (mm)	5.0 - 6.0
Rated voltage (V (AC/DC))	50
Rated current (A)	1
Transmission characteristics (Gbps)	—
Operating temperature range (°C)	-40~85

16105T



Product height (mm)	7.8
Compression range (mm)	6.0 - 7.0
Rated voltage (V (AC/DC))	50
Rated current (A)	1
Transmission characteristics (Gbps)	—
Operating temperature range (°C)	-40~85

Card Edge Connectors



The card edge connector is a type of socket connector which is used by inserting a module card into a card slot. The card edge connector is ideal for connection to the motherboard of personal computers and various expansion cards.

18010S

High speed 0.5 Pitch



Pitch (mm)	0.5
Mating direction (ST/RA)	RA
Lock method	—
Product height (mm)	7.75
Pins	230
Rated voltage (V (AC/DC))	50
Rated current (A)	0.5
Transmission characteristics (Gbps)	8.0/Qseven
Operating temperature range (°C)	-40~105

I/O Connectors



I/O (input/output) connectors, also called interface (I/F) connectors, connect information and signals between devices. They can be installed in a variety of devices, from in-vehicle devices such as car navigation systems and car audio systems to PC peripherals, and can supply power to devices and input/output audio and video signal data.

9491B

2.2 Pitch



Pitch (mm)	2.2
Mating direction (ST/RA)	ST/RA
Lock method	—
Array	1 row/2 rows
Product height (mm)	23.40
Pins	4-40
Rated voltage (V (AC/DC))	250
Rated current (A)	3
Transmission characteristics (Gbps)	—
Operating temperature range (°C)	-40~105

6661S (with Outer housing)

High speed

0.8 Pitch



Pitch (mm)	0.8
Mating direction (ST/RA)	RA
Lock method	—
Array	1 row
Product height (mm)	13.00
Pins	4/5
Rated voltage (V (AC/DC))	250
Rated current (A)	1
Transmission characteristics (Gbps)	0.48(USB2.0)
Operating temperature range (°C)	-40~85

6662S (with Outer housing)

High speed

0.8 Pitch



Pitch (mm)	0.8
Mating direction (ST/RA)	ST
Lock method	—
Array	1 row
Product height (mm)	20.10
Pins	4/5
Rated voltage (V (AC/DC))	250
Rated current (A)	1
Transmission characteristics (Gbps)	0.48(USB2.0)
Operating temperature range (°C)	-40~85

High-Speed I/O Connectors

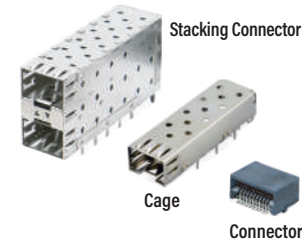

High-speed I/O connectors are an important component for building optimal transmission networks. These are used to connect network switches and other network devices (such as servers and transceivers) for transmitting data. In response to demand for higher speed and greater compactness, our diverse lineup provides high density, high bandwidth, and cost-effective solutions for customer devices.

100Gb QSFP28 (4 channels)

1-by conn | 1-by cage | 2-by combo



Connector	80012S
Stacking Connector	80023S
Cage	80013S 80022S

48Gb MiniSAS HD (4 channels)

internal | external



Connector	80024S
Cage	80025S

40Gb QSFP+ (4 channels)

1-by conn | 1-by cage | 2-by combo



Connector	80011S
Stacking Connector	80020S 80021S
Cage	80010S 80019S

28Gb SFP28 (1 channels)

1-by conn | 1-by cage



Connector	80008S
-----------	--------

10Gb SFP+ (1 channels)

1-by conn | 1-by cage | 2-by combo

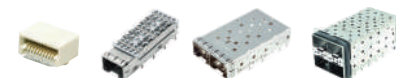

Connector	80007S
Stacking Connector	80001S 80003S 80016S
Cage	80009S 80015S

1Gb SFP (1 channels)

1-by conn | 1-by cage | 2-by combo

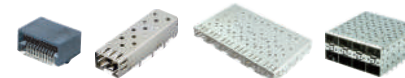

Connector	80005S
Stacking Connector	80002S
Cage	80006S

10Gb XFP (1 channels)

conn | 1-port cage



Connector	80018S
-----------	--------

ESD Protector Chip

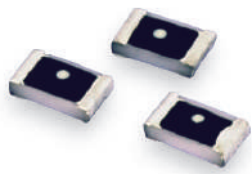

ESD protector chip developed with IRISO's proprietary technology. Low capacitance makes it ideal for electrostatic protection of high-frequency digital equipment. Simply install between the signal line and the GND line to instantly avoid ESD energy entering the circuit. Also, we have commercialized various ESD film-equipped connectors with electrostatic films based on this technology.

6803



Product height (mm)	0.4
Rated voltage (V (AC/DC))	11AC/15DC
Operating temperature range (°C)	-40~105
Note	1.0mm x 0.5mm size Electro-Static Discharge (ESD) countermeasure components

6802



Product height (mm)	0.55
Rated voltage (V (AC/DC))	14AC/20DC
Operating temperature range (°C)	-40~105
Note	1.6mm x 0.8mm size Electro-Static Discharge (ESD) countermeasure components

6801



Product height (mm)	0.55
Rated voltage (V (AC/DC))	17AC/25DC
Operating temperature range (°C)	-40~105
Note	2.0mm x 1.25mm size Electro-Static Discharge (ESD) countermeasure components

Reverse dictionary

Series	Product Category	Connector Type	Pitch, size, or height range	Mating Type	Page
10102B	Board to Board Connectors	Floating	0.80mmPitch	ST	37
10102S	Board to Board Connectors	Floating	0.80mmPitch	ST	38
10106B	Board to Board Connectors	Floating	0.5mmPitch	ST	32
10106S	Board to Board Connectors	Floating	0.5mmPitch	ST	31
10109B	Board to Board Connectors	Floating	0.635mmPitch	ST	35
10109S	Board to Board Connectors	Floating	0.635mmPitch	ST	35
10110B	Board to Board Connectors	Floating	0.635mmPitch	RA	35
10112B	Board to Board Connectors	Floating	0.5mmPitch	RA	31
10112S	Board to Board Connectors	Floating	0.5mmPitch	ST	31
10120B	Board to Board Connectors	Z-Move™	2.0mmPitch	ST	25
10120S	Board to Board Connectors	Z-Move™	2.0mmPitch	ST	25
10121S	Board to Board Connectors	Floating	0.5mmPitch	ST	30
10122B	Board to Board Connectors	Floating	11.0mmPitch	ST	46
10122S	Board to Board Connectors	Floating	11.0mmPitch	ST	46
10126B	Board to Board Connectors	Floating	0.4mmPitch	ST	27
10126S	Board to Board Connectors	Floating	0.4mmPitch	ST	27
10127B	Board to Board Connectors	Z-Move™	2.0mmPitch	ST	25
10127S	Board to Board Connectors	Z-Move™	2.0mmPitch	ST	25
10128B	Board to Board Connectors	Z-Move™	0.8mmPitch	ST	25
10128S	Board to Board Connectors	Z-Move™	0.8mmPitch	ST	25
10133B	Board to Board Connectors	Z-Move™	0.5mmPitch	ST	25
10136B	Board to Board Connectors	Floating	0.4mmPitch	ST	27
10136S	Board to Board Connectors	Floating	0.4mmPitch	ST	27
10141S	Board to Board Connectors	Floating	0.5mmPitch	ST	31
10143B	Board to Board Connectors	High-Speed Transmission	0.5mmPitch	ST	22
10143S	Board to Board Connectors	High-Speed Transmission	0.5mmPitch	ST	22
10144B	Board to Board Connectors	High-Speed Transmission	0.5mmPitch	RA	22
11007S	Board to Board Connectors	Floating	0.4mmPitch	ST	27
11010B	Board to Board Connectors	Non Floating	0.4mmPitch	ST	27
11010S	Board to Board Connectors	Non Floating	0.4mmPitch	ST	27

Series	Product Category	Connector Type	Pitch, size, or height range	Mating Type	Page
11501S	FPC/FFC Connectors Auto I-Lock™	FPC/FFC	0.5mmPitch	RA	58
11503S	FPC/FFC Connectors Auto I-Lock™	FPC/FFC	0.5mmPitch	RA	58
11600S	FPC/FFC Connectors Auto I-Lock™	FPC/FFC	0.5mmPitch	ST	57
12001S	FPC/FFC Connectors I-Lock™	FPC/FFC	0.5mmPitch	RA	57
12003S	FPC/FFC Connectors FLIP	FPC/FFC	0.5mmPitch	RA	57
13014B	Pin header Connectors	Pin Header	2.54mmPitch	RA	48
13065B	Wire Harness Connetors	BtoW	2.0mmPitch	RA	53
13065S	Wire Harness Connetors	BtoW	2.0mmPitch	RA	53
13103B	Wire Harness Connetors	BtoW	2.0mmPitch	RA	53
13103S	Wire Harness Connetors	BtoW	2.0mmPitch	RA	53
16105T	Compression Terminal	Compression Terminal	6.0~7.0		66
16106T	Compression Terminal	Compression Terminal	5.0~6.0		66
16109T	Compression Terminal	Compression Terminal	0.85~1.4		64
18010S	Card Edge Connectors	Card Edge	0.5mmPitch	RA	67
18021S	Device Socket (Power Module)	Z-Move™	2.54mmPitch	ST	50
4039T	Compression Terminal	Compression Terminal	1.1		64
4055T	Compression Terminal	Compression Terminal	2.85		65
4056T	Compression Terminal	Compression Terminal	0.8~1.0		63
4066T	Compression Terminal	Compression Terminal	1.95~2.25		65
4067T	Compression Terminal	Compression Terminal	0.7~0.9		63
4076T	Compression Terminal	Compression Terminal	2.45~2.85		65
4080T	Compression Terminal	Compression Terminal	4.5~6.5		66
4099T	Compression Terminal	Compression Terminal	1.6~2.1		64
4101T	Compression Terminal	Compression Terminal	2.1~2.5		65
4102T	Compression Terminal	Compression Terminal	1.25~1.6		64
4103T	Compression Terminal	Compression Terminal	0.6~1.1		63
4104T	Compression Terminal	Compression Terminal	0.9~1.1		63
6801	ESD Protector Chips	ESD Protector Chips	2.0×1.25mm size		70
6802	ESD Protector Chips	ESD Protector Chips	1.6×0.8mm size		70
6803	ESD Protector Chips	ESD Protector Chips	1.0×0.5mm size		70

Reverse dictionary

Series	Product Category	Connector Type	Pitch, size, or height range	Mating Type	Page
6661S	I/O Connectors	I/O Connectors	with outer mold	RA	68
6662S	I/O Connectors	I/O Connectors	with outer mold	RA	68
9110B	Board to Board Connectors	Non Floating	2.0mmPitch	ST	44
9110S	Board to Board Connectors	Non Floating	2.0mmPitch	ST/RA	44
9111B	Board to Board Connectors	Non Floating	2.0mmPitch	ST	44
9111S	Board to Board Connectors	Non Floating	2.0mmPitch	ST/RA	44
9115B	Board to Board Connectors	Non Floating	2.0mmPitch	ST	44
9115S	Board to Board Connectors	Non Floating	2.0mmPitch	ST/RA	44
9201B	Pin header Connectors	Pin Header	2.54mmPitch	ST	48
9203B	Pin header Connectors	Pin Header	2.54mmPitch	RA	49
9210B	Pin header Connectors	Pin Header	2.0mmPitch	ST	48
9240S	Device Socket (LCD)	Non Floating	2.0mmPitch	ST	51
9242S	Device Socket (LCD)	Non Floating	2.0mmPitch	ST	51
9257S	Device Socket (LCD)	Non Floating	2.0mmPitch	ST	51
9261B	Pin header Connectors	Pin Header	2.54mmPitch	ST	49
9491B	I/O Connectors	I/O Connectors	2.2mmPitch	ST/RA	68
9604S	FPC/FFC Connectors NON-ZIF	FPC/FFC	1.25mmPitch	ST/RA	61
9616S	FPC/FFC Connectors ZIF	FPC/FFC	1.00mmPitch	RA	61
9617S	FPC/FFC Connectors ZIF	FPC/FFC	1.00mmPitch	RA	61
9619S	FPC/FFC Connectors ZIF	FPC/FFC	1.00mmPitch	ST	61
9631S	FPC/FFC Connectors ZIF	FPC/FFC	0.5mmPitch	RA	60
9632S	FPC/FFC Connectors ZIF	FPC/FFC	0.5mmPitch	RA	59
9637S	FPC/FFC Connectors FLIP	FPC/FFC	0.5mmPitch	RA	59
9639S	FPC/FFC Connectors ZIF	FPC/FFC	0.5mmPitch	ST	59
9663S	FPC/FFC Connectors ZIF/I-Lock™	FPC/FFC	1.00mmPitch	RA	60
9664S	FPC/FFC Connectors ZIF/I-Lock™	FPC/FFC	1.00mmPitch	RA	60
9665S	FPC/FFC Connectors ZIF/I-Lock™	FPC/FFC	1.00mmPitch	ST	60
9671S	FPC/FFC Connectors FLIP	FPC/FFC	0.3mmPitch	RA	57
9685S	FPC/FFC Connectors I-Lock™	FPC/FFC	0.5mmPitch	RA	59
9686S	FPC/FFC Connectors I-Lock™	FPC/FFC	0.5mmPitch	RA	58

Series	Product Category	Connector Type	Pitch, size, or height range	Mating Type	Page
9687S	FPC/FFC Connectors I-Lock™	FPC/FFC	0.5mmPitch	ST	58
9827B	Board to Board Connectors	Floating	0.80mmPitch	ST	37
9827S	Board to Board Connectors	Floating	0.80mmPitch	ST	38
9828B	Board to Board Connectors	Floating	0.80mmPitch	RA	37
9828S	Board to Board Connectors	Floating	0.80mmPitch	ST	38
9850B	Board to Board Connectors	Floating	1.00mmPitch	RA	40
9850S	Board to Board Connectors	Floating	1.00mmPitch	ST	41
9851B	Board to Board Connectors	Floating	1.00mmPitch	ST	40
9851S	Board to Board Connectors	Floating	1.00mmPitch	ST	42
9852S	Board to Board Connectors	Floating	1.00mmPitch	ST	42
9853B	Board to Board Connectors	Floating	1.00mmPitch	ST	40
9853S	Board to Board Connectors	Floating	1.00mmPitch	RA	40
9854B	Board to Board Connectors	Floating	1.00mmPitch	ST	41
9854S	Board to Board Connectors	Floating	1.00mmPitch	ST	42
9855B	Board to Board Connectors	Floating	1.00mmPitch	ST	41
9855S	Board to Board Connectors	Floating	1.00mmPitch	ST	42
9856B	Board to Board Connectors	Floating	1.00mmPitch	ST	41
9856S	Board to Board Connectors	Floating	1.00mmPitch	ST	43
9860B	Board to Board Connectors	Floating	0.80mmPitch	ST	37
9880B	Board to Board Connectors	Floating	9.2mmPitch	ST	46
9880S	Board to Board Connectors	Floating	9.2mmPitch	ST	46
9984B	Board to Board Connectors	Floating	0.5mmPitch	ST	30
9984S	Board to Board Connectors	Z-Move	0.5mmPitch	ST	25
9984S	Board to Board Connectors	Floating	0.5mmPitch	RA	30
9985S	Board to Board Connectors	Floating	0.5mmPitch	RA	30

Worldwide

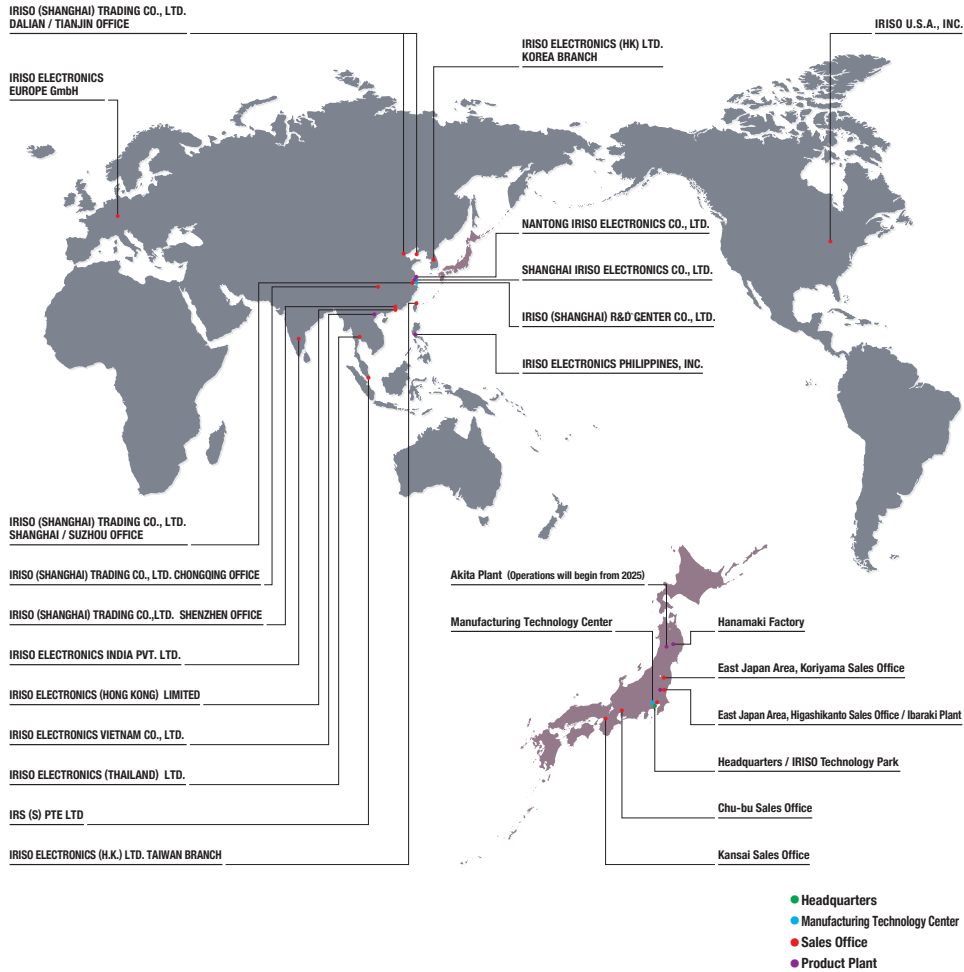

Headquarters / IRISO Technology Park



Manufacturing Technology Center



Ibaraki Plant



SHANGHAI IRISO ELECTRONICS CO., LTD.



NANTONG IRISO ELECTRONICS CO., LTD.



IRISO ELECTRONICS PHILIPPINES, INC.



IRISO ELECTRONICS VIETNAM CO., LTD.

List of Locations

Headquarters (IRISO Technology Park)

2-13-8 Shinyokohama, Kohoku-ku, Yokohama, Kanagawa, 222-0033, Japan

TEL : 045-478-3111

Domestic Sales Office

Headquarters Sales Department

2-13-8 Shinyokohama, Kohoku-ku, Yokohama, Kanagawa, 222-0033, Japan
TEL : 045-478-3545

East Japan Area, Koriyama Sales Office

Room 501, Masuko Nakamachi Building, 15-9 Nakamachi, Koriyama, Fukushima 963-8004, Japan
TEL : 024-905-0131

East Japan Area, Higashikanto Sales Office

714-1 Kami-Iwase, Hitachi-Omiya, Ibaraki 319-2142, Japan
TEL : 0295-53-1108

Kansai Sales Office

Otemae Tanaka Building 8F, 2-2-18 Tanimachi, Chuo-ku, Osaka, 540-0012, Japan
TEL : 06-6949-1123

Chubu Sales Office

701 Nagoya Mitsui Building New Wing, 1-24-20, Meieki Minami, Nakamura-ku, Nagoya, Aichi, 450-0003, Japan
TEL : 052-770-2581

Asia

IRS (S) PTE LTD

29, International Business Park #05-01 Acer Building Tower A Singapore, 609923, Singapore
TEL : 65-68624866

IRISO ELECTRONICS INDIA PVT. LTD.

Regus Eversun Business Centre, Ground Floor, E1 Block, Manyata Embassy Business Park, Outer Ring Road, Nagawara, Bengaluru 560045, India
TEL : 91-80 4276 4501

IRISO ELECTRONICS (THAILAND) LTD.

Room34, 3rd Floor, 43 Thai CC Tower, South Sathorn Road, Yannawa, Sathorn, Bangkok, 10120, Thailand
TEL : 66-2-675-8559

IRISO (SHANGHAI) TRADING CO., LTD.

Room 2202, Building T2, Everbright Anshi Center, No.398 Huoshan Road, Yangpu District, Shanghai, 200082, P.R.China
TEL : 86-21-58352770

SUZHOU OFFICE

IRISO (SHANGHAI) TRADING CO., LTD. SUZHOU OFFICE

24D2 Kings Tower, 12 Shishan Road, New District Suzhou, 215011, P.R.China
TEL : 86-512-68070100

DALIAN OFFICE

IRISO (SHANGHAI) TRADING CO., LTD. DALIAN OFFICE

Rm. 1101B, No.68 Ren Min Road, Gold Name Tower, Zhong Shan District, Dalian, 116001, P.R.China
TEL : 86-418-2738155

TIANJIN OFFICE

IRISO (SHANGHAI) TRADING CO., LTD. TIANJIN OFFICE

Room 3507, Golden Emperor Building, No.20 Nanjing Road, Hexi District, Tianjin, P.R.China
TEL : 86-22-2312877

CHONGQING OFFICE

IRISO (SHANGHAI) TRADING CO., LTD. CHONGQING OFFICE

Rm2206, Hongding Guoji Building C, No.32 Yubei Sancun, Jiangbei, Chongqing, 400020, P.R.China
TEL : 86-23-67637844

SHENZHEN OFFICE

IRISO (SHANGHAI) TRADING CO., LTD. SHENZHEN OFFICE

24F#2402, Block B, Platinum Towers, Binhe Rd, Futian Dist., Shenzhen, 518002, P.R.China
TEL : 86-755-88309074

IRISO ELECTRONICS (HONG KONG) LIMITED

Unit D, 12/F Legend Tower, No.7 Shing Yip Street, Kwun Tong, Kowloon, Hong Kong
TEL : 852-2750-2299

TAIWAN REPRESENTATIVE OFFICE

IRISO ELECTRONICS (H.K.) LTD. TAIWAN BRANCH

Room401, No.372, Lin Shen North Road, Taipei, 10421, Taiwan
TEL : 886-2-2564-3145

KOREA BRANCH

IRISO ELECTRONICS (HK) LTD. KOREA BRANCH

A-302, 230, Simin-Daero, Dongan-gu, Anyang-si, Gyeonggi-do, 14067, Korea
TEL : 82-31-478-1774

USA

IRISO U.S.A., INC.

34405 West Twelve Mile Road, Suite 237 Farmington Hills, MI 48331, U.S.A.
TEL : 1-248-324-9780

EU

IRISO ELECTRONICS EUROPE GmbH

Zettachring 10, Stuttgart-Fasanenhof, 70567, Germany
TEL : 49-711-451049-0

Development and production sites in Japan

Head office (IRISO Technology Park)

2-13-8 Shinyokohama, Kohoku-ku, Yokohama, Kanagawa, 222-0033, Japan
TEL : 045-478-3111

Manufacturing Technology Center

2-35-8 Kitamikata, Takatsu-ku, Kawasaki, Kanagawa, 213-0005, Japan
TEL : 044-911-6311

Ibaraki Plant

714-1 Kami-Iwase, Hitachi-Omiya, Ibaraki 319-2142, Japan
TEL : 0295-52-2731

Hanamaki Factory

18-14-42 Kitayuguchi, Hanamaki-shi Iwate 025-0301, Japan
TEL : 0198-27-3901

Development and production sites outside Japan

Shanghai R&D Center

IRISO (SHANGHAI) R&D CENTER CO., LTD.

No.2388, Rongle Dong Road, Songjiang, Shanghai, 201600, P.R.China
TEL : 86-21-5774-2968

IRISO ELECTRONICS PHILIPPINES, INC.

Cavite Economic Zone Lot Nos. 10 & 12, Block 22 Phase IV Rosario, Cavite 4106, Philippines
TEL : 63-46-437-0440

IRISO ELECTRONICS VIETNAM CO., LTD.

Land lot No. CN1-1, Tan Truong Industrial Zone, Cam Giang District, Hai Duong Province, 3000, Vietnam
TEL : 84-2203-570080

Shanghai Plant

SHANGHAI IRISO ELECTRONICS CO., LTD

No.2388, Rongle Dong Road, Songjiang, Shanghai, 201600, P.R.China
TEL : 86-21-5774-2968

Nantong Plant

NANTONG IRISO ELECTRONICS CO., LTD.

No.7 Hongxingdong Road, Economic and Technological Development Zone, Nantong City, Jiangsu Province, 226015, P.R.China
TEL : 86-0513-85256666