

Amphenol
ANYTEK

DIN Rail[®] Terminal Block[®]

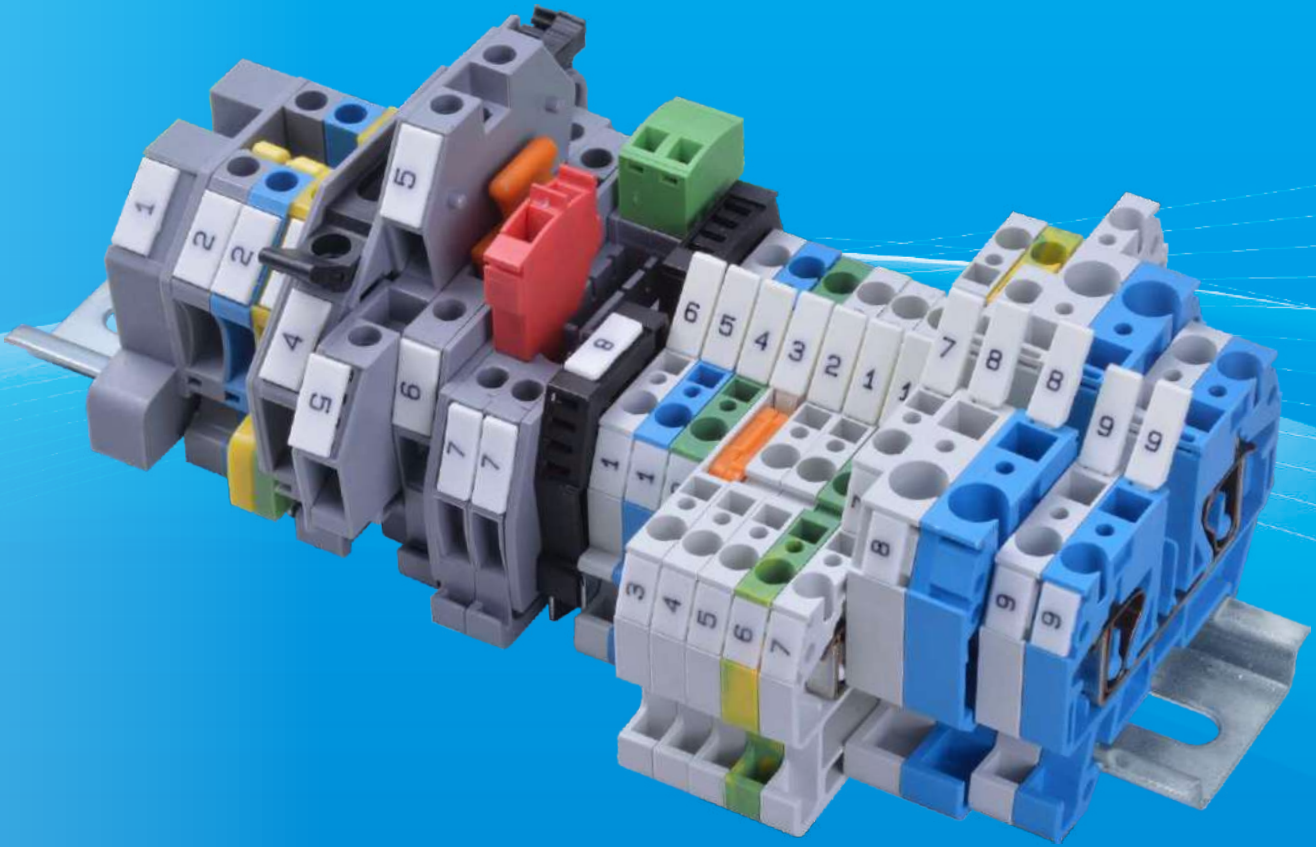

cRU_{us}

RU



ISO-9001 ISO-14001

INDUSTRIAL@AMPHENOL
TRUSTED GLOBALLY

Amphenol ANYTEK

As one of the member company of Amphenol Group, Anytek concentrates on terminal blocks designing and production over 20 years, our research and development ability will always provide customers with new designs, reasonable prices and efficient services to meet their various demands.



Taipei Head Quarter - since 1997

Based on leading production technology, especially for automatic assembly, our high quality products bring best solution to different customers, and widely used in Electric Power, Industrial Control, Security and Protection, Lighting, Elevator, Info-communication and so on. All of our products meet UL, CSA or VDE regulations, and also EU Directive RoHS compliant.

Anytek set up sales network all over the world, Asia, Europe, America etc., worldwide customers also grant us quick knowledge on their new requirement and market development trend, which also is the important engine for Anytek to innovate insistently, and grow up with customers simultaneously.



Shenzhen Factory - since 1998











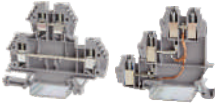

Shanghai Factory - since 2002



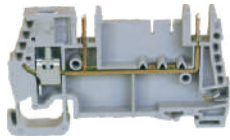

CONTENT

➤	Products Overview	01
➤	Connection Technologies	03
➤	Screw Terminal Blocks	05
	· Screw Terminal Blocks	06
	· Screw Ground Terminal Blocks	14
	· Screw Multilevel Terminal Blocks	20
➤	Spring Clamp Terminal Blocks	26
	· Spring Clamp Terminal Blocks	27
	· Spring Clamp Multilevel Terminal Blocks	30
	· Spring Clamp Ground Terminal Blocks	34
➤	Pluggable Terminal Blocks	39
	· Screw Pluggable Terminal Blocks	40
	· Spring Clamp Pluggable Terminal Blocks	43
➤	Universal Terminal Blocks	47
	· Screw Universal Terminal Blocks	48
	· Spring Clamp Universal Terminal Blocks	53
	· Equipment	57
➤	Power Terminal Blocks	60
	· Usual Type	61
	· Closed Type	67
➤	Test and Measurement Terminal Blocks	80
	· Screw Test and Measurement Terminal Blocks	81
	· Spring Clamp Test and Measurement Terminal Blocks	84
➤	Accessories	87
➤	Index	102

DIN RAIL TERMINAL BLOCKS

Screw Terminal Blocks			Spring Clamp Terminal Blocks		
Screw	Screw Ground	Screw Multilevel	Spring Clamp	Spring Multilevel	Spring Ground
					
Page 6	Page 14	Page 20	Page 27	Page 30	Page 34

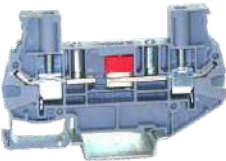
Pluggable Terminal Blocks		Universal Terminal Blocks		
Screw Pluggable	Spring Clamp Pluggable	Screw Technology	Spring Technology	Universal Equipment
				
Page 40	Page 43	Page 48	Page 53	Page 57

Power Terminal Blocks		Test and Measurement Terminal Blocks	
Usual Type	Closed Type	Screw	Spring Clamp
	Single  Multiple 		
Page 61	Page 67	Page 81	Page 84

▶ COMMON ACCESSORIES



End Plates for Screw Terminal Blocks



End Plates for Pluggable Terminal Blocks without Holes



End Plates for Pluggable Terminal Blocks with Holes



End Plates for Two and Three Stage Terminal Blocks



Red Test Plug Adaptor



Black Test Plug Adaptor

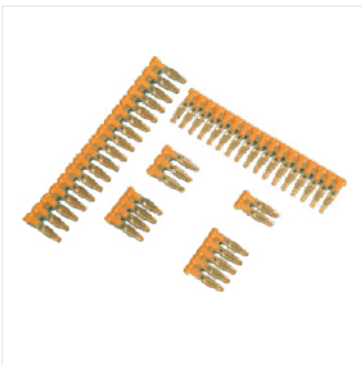

Jumper Bar, Pitch: 5.1mm

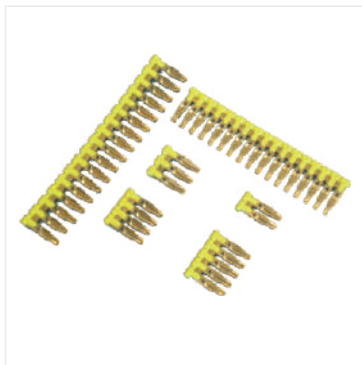

Jumper Bar, Pitch: 6.1mm

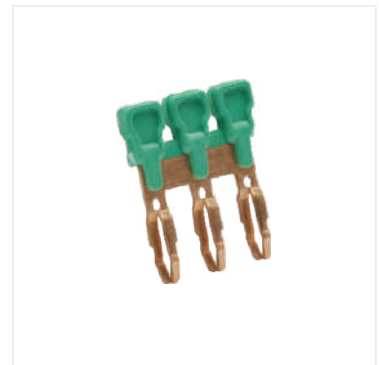

Jumper Bar, Pitch: 8.1mm

► SCREW CLAMP TECHNOLOGY

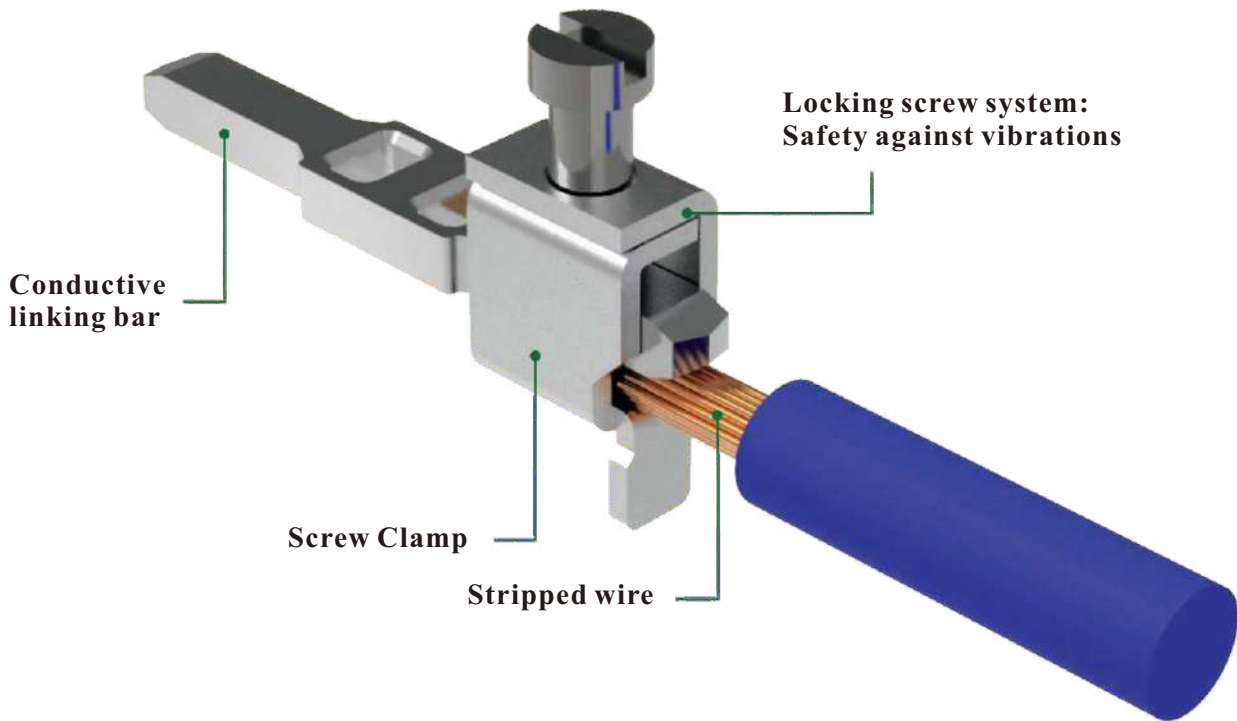

Screw terminal blocks are designed for the most stringent requirements. This technology was introduced more than 80 years ago and still remains the most popular connection method in the market.

Anytek's screw clamp technology has a built-in protection to prevent the conductor from becoming loose. When the screw is tightened, the pressure pulls apart both halves of the clamping yoke and generate a high locking action on the screw. This screw clamping system provides excellent vibration resistance.

Screw terminal blocks from Anytek are maintenance-free and the vibration-resistant screw clamp guarantees a good contact force and a stable, secure connection.

▶ SPRING CLAMP TECHNOLOGY

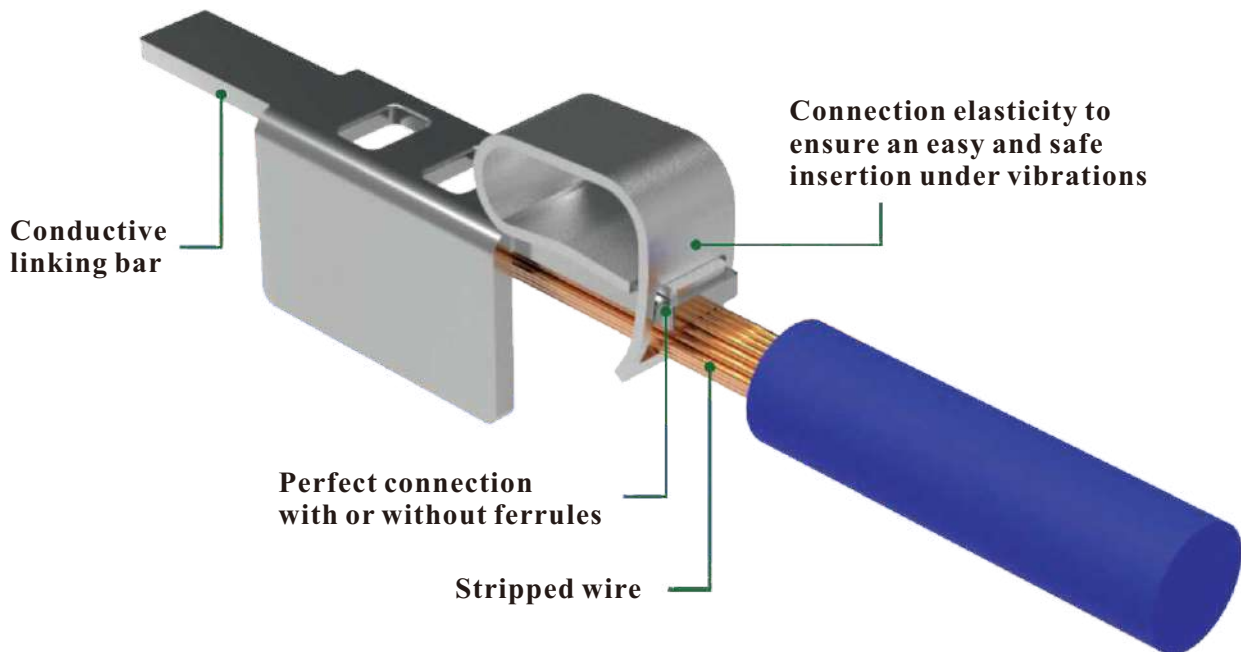

Spring clamp terminal blocks are designed as an alternative to the screw clamp technology and accommodate conductor sizes up to 10.0mm².

The stainless steel spring presses the conductor directly onto the current bar. Due to the special design of the clamping body, the contact force is further increased when the conductor is being pulled. The contact force is independent of the user and creates a vibration-proof, gas-tight connection with long term stability.

The terminal point is opened with a standard screwdriver. After the conductor is inserted into the clamping space, the screwdriver is removed and the conductor automatically makes contact.

The conductors do not need special pre-treatment and this system gives more space for inserting flexible conductors with ferrules.

► SCREW TERMINAL BLOCKS

The modular screw terminal blocks is the most reliable solution in the market, with high locking action to provide excellent vibration resistance and high current rating.

The screw terminal blocks solution is comprehensive with conductor sizes ranging from 2.5mm² to 95.0mm².



TARGET MARKETS

- Control Cabinets for Machinery
- Control Cabinets for Buildings
- Power Distribution Cabinets
- Process Automation

FEATURES

- Comprehensive range of wire cross section
- Compact design
- Large connection space
- Optimum guidance for the screwdriver
- Good contact stability – permanently
- Vibration resistance clamp
- Small quantity per pack
- RoHS compliant, lead-free, halogen-free

BENEFITS

- Complete product offering for all customer needs
- Space saving
- Enables rigid and flexible conductors
- Easy to install
- Maintenance-free
- Stable and durable connections
- User flexibility
- Meets environmental, health and safety requirements

► SCREW TERMINAL BLOCKS



2.5mm² - 1000V - 24A

Approval

Approval	Voltage Rating (V)	Current Rating (A)
UL	600	20
VDE	1000	24
RINA	1000	24
Kema EX	II 2 GD EEx e II 03A TEX2118 U	

Part Number

Color	Part Number	Quantity (Pieces) per pack
Grey	10134250-001LF	100
Black	10134250-002LF	
Blue	10134250-003LF	
Brown	10134250-004LF	
Yellow Green	10134250-005LF	
Green	10134250-006LF	
Yellow	10134250-007LF	
Orange	10134250-008LF	
Red	10134250-009LF	
White	10134250-010LF	

Technical Information

Rated Cross Section (mm ²)	Rigid Conductor (mm ²)	Flexible Conductor (mm ²)	Wire Gauge (AWG)	Dimension (Length x Height x Thickness) (mm)	Stripping Length (mm)	Screw	Tightening Torque
2.5	0.5-4.0	0.5-4.0	24-12	47 x 36 x 5	9	M2.6	0.5Nm/ 4.0 Lb-In

Accessories

Description	Part Number	Quantity (Pieces) per pack	Page
Marking Tags(5mm x 3mm)	10134398-001LF~ 10134398-041LF	100	87~88
Marking Tags(5mm x 12mm)	10134400-001LF	500	89
End Bracket width 9mm	10134389-001LF	50	97
End Bracket width 6mm	10134390-001LF		97
Fast-snap End Bracket	10134391-001LF		97
End Plate	10134259-001LF	100	92
Separator	10134263-001LF		92
Jumper Bar pitch 5,1mm 2 Poles	10134273-001LF		99
Jumper Bar pitch 5,1mm 3 Poles	10134273-002LF		99
Jumper Bar pitch 5,1mm 24 Poles	10134273-003LF	5	99
Ratchet Cutting Tool for jumper bar	10134271-001LF	1	101
Red Test Plug Adapter	10134276-001LF	10	96
Black Test Plug Adapter	10134276-002LF		96

► SCREW TERMINAL BLOCKS



4mm² - 1000V - 32A

Approval

Approval	Voltage Rating (V)	Current Rating (A)
UL	600	30
VDE	1000	32
RINA	1000	32
Kema EX	II 2 GD EEx e II 03A TEX2118 U	

Part Number

Color	Part Number	Quantity (Pieces) per pack
Grey	10134251-001LF	100
Black	10134251-002LF	
Blue	10134251-003LF	
Brown	10134251-004LF	
Yellow Green	10134251-005LF	
Green	10134251-006LF	
Yellow	10134251-007LF	
Orange	10134251-008LF	
Red	10134251-009LF	
White	10134251-010LF	

Technical Information

Rated Cross Section (mm ²)	Rigid Conductor (mm ²)	Flexible Conductor (mm ²)	Wire Gauge (AWG)	Dimension (Length x Height x Thickness) (mm)	Stripping Length (mm)	Screw	Tightening Torque
4.0	0.5-6.0	0.5-6.0	24-10	47.4 x 36 x 6	9	M3	0.6Nm/ 7.0 Lb-In

Accessories

Description	Part Number	Quantity (Pieces) per pack	Page
Marking Tags(5mm x 3mm)	10134398-001LF~ 10134398-041LF	100	87~88
Marking Tags(5mm x 12mm)	10134400-001LF	500	89
Marking Tags(6mm x 12mm)	10134401-001LF	500	89
End Bracket width 9mm	10134389-001LF	50	97
End Bracket width 6mm	10134390-001LF		97
Fast-snap End Bracket	10134391-001LF		97
End Plate	10134259-001LF	100	92
Separator	10134263-001LF		92
Jumper Bar pitch 6,1mm 2 Poles	10134272-001LF		99
Jumper Bar pitch 6,1mm 3 Poles	10134272-002LF		99
Jumper Bar pitch 6,1mm 24 Poles	10134272-003LF		5
Ratchet Cutting Tool for jumper bar	10134271-002LF	1	101
Red Test Plug Adapter	10134276-001LF	10	96
Black Test Plug Adapter	10134276-002LF		96

SCREW TERMINAL BLOCKS

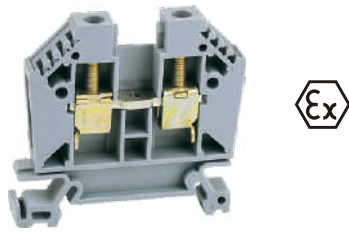

6mm² - 1000V - 41A

Approval

Approval	Voltage Rating (V)	Current Rating (A)
UL	600	50
VDE	1000	41
RINA	1000	41
Kema EX	II 2 GD EEx e II 03A TEX2118 U	

Part Number

Color	Part Number	Quantity (Pieces) per pack
Grey	10134253-001LF	50
Black	10134253-002LF	
Blue	10134253-003LF	
Brown	10134253-004LF	
Yellow Green	10134253-005LF	
Green	10134253-006LF	
Yellow	10134253-007LF	
Orange	10134253-008LF	
Red	10134253-009LF	
White	10134253-010LF	

Technical Information

Rated Cross Section (mm ²)	Rigid Conductor (mm ²)	Flexible Conductor (mm ²)	Wire Gauge (AWG)	Dimension (Length x Height x Thickness) (mm)	Stripping Length (mm)	Screw	Tightening Torque
6.0	0.5-10.0	0.5-6.0	22-8	50 x 44 x 7	12	M3.5	0.8Nm/ 10 Lb-In

Accessories

Description	Part Number	Quantity (Pieces) per pack	Page
Marking Tags(5mm x 3mm)	10134398-001LF~ 10134398-041LF	100	87~88
Marking Tags(5mm x 12mm)	10134400-001LF	500	89
Marking Tags(6mm x 12mm)	10134401-001LF	500	89
End Bracket width 9mm	10134389-001LF	50	97
End Bracket width 6mm	10134390-001LF		97
Fast-snap End Bracket	10134391-001LF		97
End Plate	10134260-001LF	100	92
Separator	10134264-001LF		92
Insulated Screw Jumper pitch 7,1mm 2 poles	10134275-001LF	100	99
Insulated Screw Jumper pitch 7,1mm 3 poles	10134275-002LF	100	99
Insulated Screw Jumper pitch 7,1mm 24 poles	10134275-003LF	5	99
Red Test Plug Adapter	10134276-001LF	10	96
Black Test Plug Adapter	10134276-002LF		96
No tools needed for the Plug-in Jumper			

► SCREW TERMINAL BLOCKS

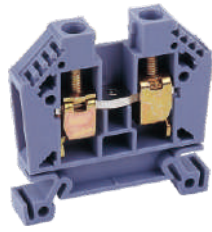

10mm² - 1000V - 57A

Approval

Approval	Voltage Rating (V)	Current Rating (A)
UL	600	65
VDE	1000	57
RINA	1000	57
Kema EX	II 2 GD EEx e II 03A TEX2118 U	

Part Number

Color	Part Number	Quantity (Pieces) per pack
Grey	10134254-001LF	50
Blue	10134254-002LF	
Yellow Green	10134254-003LF	
Yellow	10134254-004LF	
Orange	10134254-005LF	
Red	10134254-006LF	

Technical Information

Rated Cross Section (mm ²)	Rigid Conductor (mm ²)	Flexible Conductor (mm ²)	Wire Gauge (AWG)	Dimension (Length x Height x Thickness) (mm)	Stripping Length (mm)	Screw	Tightening Torque
10.0	1.5-16.0	1.5-10.0	20-6	50 x 44 x 9	12	M4	1.2Nm/ 20 Lb-In

Accessories

Description	Part Number	Quantity (Pieces) per pack	Page
Marking Tags(5mm x 3mm)	10134398-001LF~ 10134398-041LF	100	87~88
Marking Tags(5mm x 12mm)	10134400-001LF	500	89
Marking Tags(6mm x 12mm)	10134401-001LF	500	89
End Bracket width 9mm	10134389-001LF	50	97
End Bracket width 6mm	10134390-001LF		97
Fast-snap End Bracket	10134391-001LF		97
End Plate	10134260-001LF	100	92
Separator	10134264-001LF		92
Screw Jumper Bar pitch 9.1mm	10134265-001LF	1	98
Red Test Plug Adapter	10134276-001LF	10	96
Black Test Plug Adapter	10134276-002LF		96

SCREW TERMINAL BLOCKS

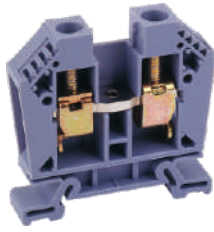

25mm² - 1000V - 101A

Approval

Approval	Voltage Rating (V)	Current Rating (A)
UL	600	85
VDE	1000	101
RINA	1000	101
Kema EX	II 2 GD EEx e II 03A TEX2118 U	

Part Number

Color	Part Number	Quantity (Pieces) per pack
Grey	10134255-001LF	25
Blue	10134255-002LF	
Yellow Green	10134255-003LF	
Yellow	10134255-004LF	

Technical Information

Rated Cross Section (mm ²)	Rigid Conductor (mm ²)	Flexible Conductor (mm ²)	Wire Gauge (AWG)	Dimension (Length x Height x Thickness) (mm)	Stripping Length (mm)	Screw	Tightening Torque
25.0	1.5-25.0	1.5-16.0	14-4	56 x 49 x 12	12	M5	2.0Nm/ 30 Lb-In

Accessories

Description	Part Number	Quantity (Pieces) per pack	Page
Marking Tags(5mm x 3mm)	10134398-001LF~ 10134398-041LF	100	87~88
Marking Tags(5mm x 12mm)	10134400-001LF	500	89
Marking Tags(6mm x 12mm)	10134401-001LF	500	89
End Bracket width 9mm	10134389-001LF	50	97
End Bracket width 6mm	10134390-001LF		97
Fast-snap End Bracket	10134391-001LF		97
End Plate	10134261-001LF		92
Screw Jumper Bar pitch 12.0mm 41 poles	10134266-001LF	1	98
Screw Jumper Bar pitch 12.0mm 2 poles	10134266-002LF	50	98

SCREW TERMINAL BLOCKS



50mm² - 1000V - 150A

Approval

Approval	Voltage Rating (V)	Current Rating (A)
UL	600	130
VDE	1000	150
RINA	1000	150
Kema EX	II 2 GD EEx e II 03A TEX2118 U	

Part Number

Color	Part Number	Quantity (Pieces) per pack
Grey	10134256-001LF	25
Blue	10134256-002LF	
Yellow Green	10134256-003LF	
Yellow	10134256-004LF	
Red	10134256-005LF	

Technical Information

Rated Cross Section (mm ²)	Rigid Conductor (mm ²)	Flexible Conductor (mm ²)	Wire Gauge (AWG)	Dimension (Length x Height x Thickness) (mm)	Stripping Length (mm)	Screw	Tightening Torque
50.0	2.5-50.0	2.5-50.0	14-1/0	62 x 61 x 16	17	M6	2.5Nm/ 45 Lb-In

Accessories

Description	Part Number	Quantity (Pieces) per pack	Page
Marking Tags(5mm x 3mm)	10134398-001LF~ 10134398-041LF	100	87~88
Marking Tags(5mm x 12mm)	10134400-001LF	500	89
Marking Tags(6mm x 12mm)	10134401-001LF	500	89
End Bracket width 9mm	10134389-001LF	50	97
End Bracket width 6mm	10134390-001LF		97
Fast-snap End Bracket	10134391-001LF		97
End Plate	10134262-001LF		92
Screw Jumper Bar pitch 16.1mm 32 poles	10134267-001LF	1 x 32	98

SCREW TERMINAL BLOCKS



70mm² - 800V - 192A

Approval

Approval	Voltage Rating (V)	Current Rating (A)
UL	600	185
VDE	800	192
RINA	800	192
Kema EX	II 2 GD EEx e II 03A TEX2118 U	

Part Number

Color	Part Number	Quantity (Pieces) per pack
Grey	10134257-001LF	10
Blue	10134257-002LF	
Yellow Green	10134257-003LF	
Yellow	10134257-004LF	

Technical Information

Rated Cross Section (mm ²)	Rigid Conductor (mm ²)	Flexible Conductor (mm ²)	Wire Gauge (AWG)	Dimension (Length x Height x Thickness) (mm)	Stripping Length (mm)	Screw	Tightening Torque
70.0	25.0-70.0	25.0-70.0	4-3/0	74 x 75 x 26	20	M8 - Ch6	4.5Nm/ 40 Lb-In

Accessories

Description	Part Number	Quantity (Pieces) per pack	Page
Marking Tags (5mm x 3mm)	10134398-001LF~ 10134398-041LF	100	87~88
Marking Tags (6mm x 12mm)	10134401-001LF	500	89
End Bracket width 9mm	10134389-001LF	50	97
End Bracket width 6mm	10134390-001LF		97
Fast-snap End Bracket	10134391-001LF		97

SCREW TERMINAL BLOCKS



95mm² - 800V - 232A

Approval

Approval	Voltage Rating (V)	Current Rating (A)
UL	600	185
IMQ	800	232

Part Number

Color	Part Number	Quantity (Pieces) per pack
Grey	10134258-001LF	10
Blue	10134258-002LF	
Yellow Green	10134258-003LF	
Yellow	10134258-004LF	

Technical Information

Rated Cross Section (mm ²)	Rigid Conductor (mm ²)	Flexible Conductor (mm ²)	Wire Gauge (AWG)	Dimension (Length x Height x Thickness) (mm)	Stripping Length (mm)	Screw	Tightening Torque
95.0	25.0-95.0	25.0-95.0	4-3/0	74 x 75 x 26	20	M8 - Ch6	4.5Nm/ 40 Lb-In

Accessories

Description	Part Number	Quantity (Pieces) per pack	Page
Marking Tags(5mm x 3mm)	10134398-001LF~ 10134398-041LF	100	87~88
Marking Tags(6mm x 12mm)	10134401-001LF	500	89
End Bracket width 9mm	10134389-001LF	50	97
End Bracket width 6mm	10134390-001LF		97
Fast-snap End Bracket	10134391-001LF		97

► SCREW GROUND TERMINAL BLOCKS



4mm²

Approval

Approval	Voltage Rating (V)	Current Rating (A)
UL	/	
RINA	/	
Kema EX	II 2 GD EEx e II 03ATEX2118 U	

Part Number

Color	Part Number	Quantity (Pieces) per pack
Yellow Green	10134279-001LF	50

Technical Information

Rated Cross Section (mm ²)	Rigid Conductor (mm ²)	Flexible Conductor (mm ²)	Wire Gauge (AWG)	Dimension (Length x Height x Thickness) (mm)	Stripping Length (mm)	Screw	Tightening Torque	Fixing Screw	Tightening Torque
4.0	0.5-6.0	0.5-4.0	24-10	58 x 36 x 7	10	M3	0.6Nm/ 7.0 Lb-In	M3.5	0.6Nm/ 7.0 Lb-In

Accessories

Description	Part Number	Quantity (Pieces) per pack	Page
Marking Tags(5mm x 3mm)	10134398-001LF~ 10134398-041LF	100	87~88
Marking Tags(6mm x 12mm)	10134401-001LF	500	89
End Bracket width 9mm	10134389-001LF	50	97
End Bracket width 6mm	10134390-001LF		97
Fast-snap End Bracket	10134391-001LF		97

SCREW GROUND TERMINAL BLOCKS

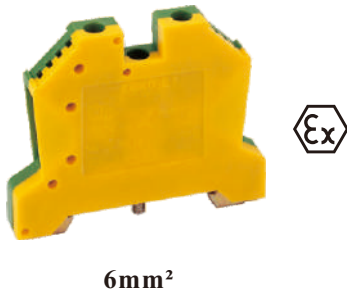

Approval

Approval	Voltage Rating (V)	Current Rating (A)
UL	/	
RINA	/	
Kema EX	II 2 GD EEx e II 03ATEX2118 U	

Part Number

Color	Part Number	Quantity (Pieces) per pack
Yellow Green	10134280-001LF	50

Technical Information

Rated Cross Section (mm ²)	Rigid Conductor (mm ²)	Flexible Conductor (mm ²)	Wire Gauge (AWG)	Dimension (Length x Height x Thickness) (mm)	Stripping Length (mm)	Screw	Tightening Torque	Screw	Tightening Torque
6.0	0.5-6.0	0.5-6.0	22-8	58 x 44 x 8	12	M3.5	0.8Nm/ 10.0 Lb-In	M3.5	0.6Nm/ 7.0 Lb-In

Accessories

Description	Part Number	Quantity (Pieces) per pack	Page
Marking Tags(5mm x 3mm)	10134398-001LF~ 10134398-041LF	100	87~88
Marking Tags(6mm x 12mm)	10134401-001LF	500	89
End Bracket width 9mm	10134389-001LF	50	97
End Bracket width 6mm	10134390-001LF		97
Fast-snap End Bracket	10134391-001LF		97

► SCREW GROUND TERMINAL BLOCKS

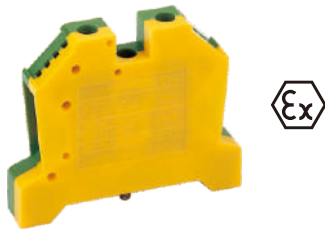

10mm²

Approval

Approval	Voltage Rating (V)	Current Rating (A)
UL	/	
RINA	/	
Kema EX	II 2 GD EEx e II 03ATEX2118 U	

Part Number

Color	Part Number	Quantity (Pieces) per pack
Yellow Green	10134281-001LF	50

Technical Information

Rated Cross Section (mm ²)	Rigid Conductor (mm ²)	Flexible Conductor (mm ²)	Wire Gauge (AWG)	Dimension (Length x Height x Thickness) (mm)	Stripping Length (mm)	Screw	Tightening Torque	Fixing Screw	Tightening Torque
10.0	1.5-10.0	1.5-10.0	20-6	58 x 44 x 10	13	M4	1.2Nm/ 20 Lb-In	M3.5	0.6Nm/ 7.0 Lb-In

Accessories

Description	Part Number	Quantity (Pieces) per pack	Page
Marking Tags(5mm x 3mm)	10134398-001LF~ 10134398-041LF	100	87~88
Marking Tags(6mm x 12mm)	10134401-001LF	500	89
End Bracket width 9mm	10134389-001LF	50	97
End Bracket width 6mm	10134390-001LF		97
Fast-snap End Bracket	10134391-001LF		97

SCREW GROUND TERMINAL BLOCKS

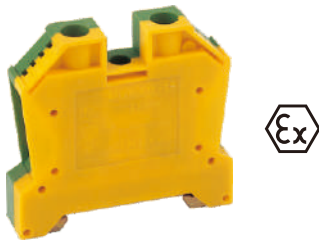

25mm²

Approval

Approval	Voltage Rating (V)	Current Rating (A)
UL	/	
RINA	/	
Kema EX	II 2 GD EEx e II 03ATEX2118 U	

Part Number

Color	Part Number	Quantity (Pieces) per pack
Yellow Green	10134283-001LF	25

Technical Information

Rated Cross Section (mm ²)	Rigid Conductor (mm ²)	Flexible Conductor (mm ²)	Wire Gauge (AWG)	Dimension (Length x Height x Thickness) (mm)	Stripping Length (mm)	Screw	Tightening Torque	Fixing Screw	Tightening Torque
25	1.5-25.0	1.5-25.0	14-4	58 x 49 x 12	14	M5	2Nm/ 30 Lb-In	M3.5	0.8Nm/ 10 Lb-In

Accessories

Description	Part Number	Quantity (Pieces) per pack	Page
Marking Tags(5mm x 3mm)	10134398-001LF~ 10134398-041LF	100	87~88
Marking Tags(6mm x 12mm)	10134401-001LF	500	89
End Bracket width 9mm	10134389-001LF	50	97
End Bracket width 6mm	10134390-001LF		97
Fast-snap End Bracket	10134391-001LF		97

► SCREW GROUND TERMINAL BLOCKS



35mm²

Part Number

Approval

Approval	Voltage Rating (V)	Current Rating (A)
UL	/	

Color	Part Number	Quantity (Pieces) per pack
Yellow Green	10134284-001LF	25

Technical Information

Rated Cross Section (mm ²)	Rigid Conductor (mm ²)	Flexible Conductor (mm ²)	Wire Gauge (AWG)	Dimension (Length x Height x Thickness) (mm)	Stripping Length (mm)	Screw	Tightening Torque	Fixing Screw	Tightening Torque
35	1.5-35.0	1.5-35.0	14-2	58 x 49 x 12	14	M5	2Nm/ 21.6 Lb-In	M3.5	0.8Nm/ 10 Lb-In

Accessories

Description	Part Number	Quantity (Pieces) per pack	Page
Marking Tags(5mm x 3mm)	10134398-001LF~ 10134398-041LF	100	87~88
Marking Tags(6mm x 12mm)	10134401-001LF	500	89
End Bracket width 9mm	10134389-001LF	50	97
End Bracket width 6mm	10134390-001LF		97
Fast-snap End Bracket	10134391-001LF		97

► SCREW GROUND TERMINAL BLOCKS



50mm²

Approval

Approval	Voltage Rating (V)	Current Rating (A)
UL	/	
RINA	/	
Kema EX	II 2 GD EEx e II 03ATEX2118 U	

Part Number

Color	Part Number	Quantity (Pieces) per pack
Yellow Green	10134285-001LF	25

Technical Information

Rated Cross Section (mm ²)	Rigid Conductor (mm ²)	Flexible Conductor (mm ²)	Wire Gauge (AWG)	Dimension (Length x Height x Thickness) (mm)	Stripping Length (mm)	Screw	Tightening Torque	Fixing Screw	Tightening Torque
50	1.5-50.0	1.5-35.0	10-1/0	62 x 60 x 16	18	M6	2.5Nm/ 45 Lb-In	M4	0.8Nm/ 10 Lb-In

Accessories

Description	Part Number	Quantity (Pieces) per pack	Page
Marking Tags(5mm x 3mm)	10134398-001LF~ 10134398-041LF	100	87~88
Marking Tags(6mm x 12mm)	10134401-001LF	500	89
End Bracket width 9mm	10134389-001LF	50	97
End Bracket width 6mm	10134390-001LF		97
Fast-snap End Bracket	10134391-001LF		97

► SCREW MULTILEVEL TERMINAL BLOCKS

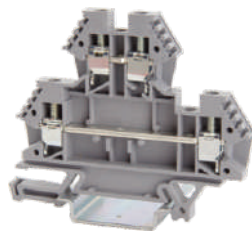

4mm² - 1000V - 32A

Approval

Approval	Voltage Rating (V)	Current Rating (A)
UL	600	30
VDE	1000	32
RINA	1000	32
Kema EX	II 2 GD EEx e II 03A TEX2118 U	

Part Number

Color	Part Number	Quantity (Pieces) per pack
Grey	10134288-001LF	50
Black	10134288-002LF	
Blue	10134288-003LF	
Brown	10134288-004LF	
Yellow Green	10134288-005LF	
Green	10134288-006LF	
Yellow	10134288-007LF	
Orange	10134288-008LF	
Red	10134288-009LF	
White	10134288-010LF	

Technical Information

Rated Cross Section (mm ²)	Level	Rigid Conductor (mm ²)	Flexible Conductor (mm ²)	Wire Gauge (AWG)	Dimension (Length x Height x Thickness) (mm)	Stripping Length (mm)	Screw	Tightening Torque
4.0	2	0.5-6.0	0.5-6.0	24-10	75 x 56 x 6	6	M3	0.6Nm/ 7.0 Lb-In

Accessories

Description	Part Number	Quantity (Pieces) per pack	Page
Marking Tags (5mm x 3mm)	10134398-001LF~ 10134398-041LF	100	87~88
Marking Tags (5mm x 12mm)	10134400-001LF	500	89
Marking Tags (6mm x 12mm)	10134401-001LF	500	89
End Bracket width 9mm	10134389-001LF	50	97
End Bracket width 6mm	10134390-001LF		97
Fast-snap End Bracket	10134391-001LF		97
End Plate	10134292-001LF		92
Jumper Bar pitch 6,1mm 2 Poles	10134272-001LF	100	99
Jumper Bar pitch 6,1mm 3 Poles	10134272-002LF		99
Jumper Bar pitch 6,1mm 24 Poles	10134272-003LF	5	99
Ratchet Cutting Tool for jumper bar	10134271-002LF	1	101
Red Test Plug Adapter	10134276-001LF	10	96
Black Test Plug Adapter	10134276-002LF		96

SCREW MULTILEVEL TERMINAL BLOCKS

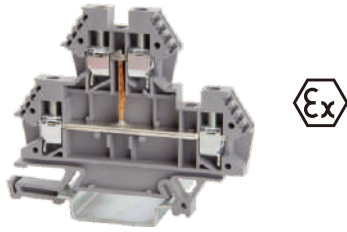

4mm² - 1000V - 32A, Cross connected

Approval

Approval	Voltage Rating (V)	Current Rating (A)
UL	600	30
VDE	1000	32
RINA	1000	32
Kema EX	II 2 GD EEx e II 03A TEX2118 U	

Part Number

Color	Part Number	Quantity (Pieces) per pack
Grey	10134289-001LF	50
Black	10134289-002LF	
Blue	10134289-003LF	
Yellow Green	10134289-004LF	
Yellow	10134289-005LF	
Red	10134289-006LF	

Technical Information

Rated Cross Section (mm ²)	Level	Rigid Conductor (mm ²)	Flexible Conductor (mm ²)	Wire Gauge (AWG)	Dimension (Length x Height x Thickness) (mm)	Stripping Length (mm)	Screw	Tightening Torque
4.0	2	0.5-6.0	0.5-6.0	24-10	75 x 56 x 6	6	M3	0.6Nm/ 7.0 Lb-In

Accessories

Description	Part Number	Quantity (Pieces) per pack	Page
Marking Tags (5mm x 3mm)	10134398-001LF~ 10134398-041LF	100	87~88
Marking Tags (5mm x 12mm)	10134400-001LF	500	89
Marking Tags (6mm x 12mm)	10134401-001LF	500	89
End Bracket width 9mm	10134389-001LF	50	97
End Bracket width 6mm	10134390-001LF		97
Fast-snap End Bracket	10134391-001LF		97
End Plate	10134292-001LF		92
Jumper Bar pitch 6,1mm 2 Poles	10134272-001LF	100	99
Jumper Bar pitch 6,1mm 3 Poles	10134272-002LF		99
Jumper Bar pitch 6,1mm 24 Poles	10134272-003LF	5	99
Ratchet Cutting Tool for jumper bar	10134271-002LF	1	101
Red Test Plug Adapter	10134276-001LF	10	96
Black Test Plug Adapter	10134276-002LF		96

► SCREW MULTILEVEL TERMINAL BLOCKS

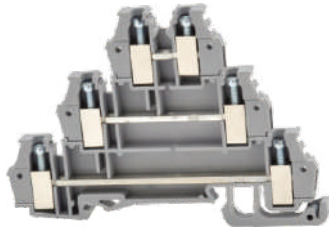

2.5mm² - 250V - 24A

Approval

Approval	Voltage Rating (V)	Current Rating (A)
UL	300	10
VDE	250	24

Part Number

Color	Part Number	Quantity (Pieces) per pack
Grey	10134294-001LF	25

Technical Information

Rated Cross Section (mm ²)	Level	Rigid Conductor (mm ²)	Flexible Conductor (mm ²)	Wire Gauge (AWG)	Dimension (Length x Height x Thickness) (mm)	Stripping Length (mm)	Screw	Tightening Torque
2.5	3	0.5-2.5	0.5-2.5	26-14	78.5 x 47.5 x 5	6	M2.5	0.5Nm/ 4.5 Lb-In

Accessories

Description	Part Number	Quantity (Pieces) per pack	Page
Marking Tags(5mm x 3mm)	10134398-001LF~ 10134398-041LF	100	87~88
Marking tags(5mm x 5.8mm)	10134402-001LF	500	89
End Bracket width 9mm	10134389-001LF	50	97
End Bracket width 6mm	10134390-001LF		97
Fast-snap End Bracket	10134391-001LF		97
End Plate	10134297-001LF	25	92
Jumper Bar pitch 5,1mm 2 poles - blue	10134414-001LF	100	100
Jumper Bar pitch 5,1mm 3 poles - blue	10134414-002LF	100	100
Jumper Bar pitch 5,1mm 12 poles - blue	10134414-003LF	10	100
Jumper Bar pitch 5,1mm 2 poles - red	10134414-004LF	100	100
Jumper Bar pitch 5,1mm 3 poles - red	10134414-005LF	100	100
Jumper Bar pitch 5,1mm 12 poles - red	10134414-006LF	10	100
Ratchet Cutting Tool for jumper bar	10134271-005LF	1	101

► SCREW MULTILEVEL TERMINAL BLOCKS

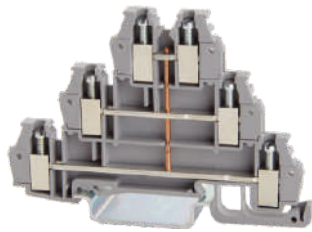

2.5mm² - 250V - 24A, Cross connected

Part Number

Approval

Approval	Voltage Rating (V)	Current Rating (A)
UL	300	10

Color	Part Number	Quantity (Pieces) per pack
Grey	10134294-002LF	25

Technical Information

Rated Cross Section (mm ²)	Level	Rigid Conductor (mm ²)	Flexible Conductor (mm ²)	Wire Gauge (AWG)	Dimension (Length x Height x Thickness) (mm)	Stripping Length (mm)	Screw	Tightening Torque
2.5	3	0.5-2.5	0.5-2.5	26-14	78.5 x 47.5 x 5	6	M2.5	0.5Nm/ 4.5 Lb-In

Accessories

Description	Part Number	Quantity (Pieces) per pack	Page
Marking Tags(5mm x 3mm)	10134398-001LF~ 10134398-041LF	100	87~88
Marking tags(5mm x 5.8mm)	10134402-001LF	500	89
End Bracket width 9mm	10134389-001LF	50	97
End Bracket width 6mm	10134390-001LF		97
Fast-snap End Bracket	10134391-001LF		97
End Plate	10134297-001LF	25	92
Jumper Bar pitch 5,1mm 2 poles - blue	10134414-001LF	100	100
Jumper Bar pitch 5,1mm 3 poles - blue	10134414-002LF	100	100
Jumper Bar pitch 5,1mm 12 poles - blue	10134414-003LF	10	100
Jumper Bar pitch 5,1mm 2 poles - red	10134414-004LF	100	100
Jumper Bar pitch 5,1mm 3 poles - red	10134414-005LF	100	100
Jumper Bar pitch 5,1mm 12 poles - red	10134414-006LF	10	100
Ratchet Cutting Tool for jumper bar	10134271-005LF	1	101

► SCREW MULTILEVEL TERMINAL BLOCKS



2.5mm² - 250V - 24A, Z type

Approval

Approval	Voltage Rating (V)	Current Rating (A)
UL	300	10
VDE	250	24

Part Number

Color	Part Number	Quantity (Pieces) per pack
Grey	10134295-001LF	25

Technical Information

Rated Cross Section (mm ²)	Level	Rigid Conductor (mm ²)	Flexible Conductor (mm ²)	Wire Gauge (AWG)	Dimension (Length x Height x Thickness) (mm)	Stripping Length (mm)	Screw	Tightening Torque
2.5	3	0.5-2.5	0.5-2.5	26-14	62 x 47.5 x 5	6	M2.5	0.5Nm/ 4.5 Lb-In

Accessories

Description	Part Number	Quantity (Pieces) per pack	Page
Marking Tags(5mm x 3mm)	10134398-001LF~ 10134398-041LF	100	87~88
Marking tags(5mm x 5.8mm)	10134402-001LF	500	89
End Bracket width 9mm	10134389-001LF	50	97
End Bracket width 6mm	10134390-001LF		97
Fast-snap End Bracket	10134391-001LF		97
End Plate	10134298-001LF	25	92
Jumper Bar pitch 5,1mm 2 poles - blue	10134414-001LF	100	100
Jumper Bar pitch 5,1mm 3 poles - blue	10134414-002LF	100	100
Jumper Bar pitch 5,1mm 12 poles - blue	10134414-003LF	10	100
Jumper Bar pitch 5,1mm 2 poles - red	10134414-004LF	100	100
Jumper Bar pitch 5,1mm 3 poles - red	10134414-005LF	100	100
Jumper Bar pitch 5,1mm 12 poles - red	10134414-006LF	10	100
Ratchet Cutting Tool for jumper bar	10134271-005LF	1	101

► SCREW MULTILEVEL TERMINAL BLOCKS



2.5mm² - 250V - 24A, Z type Cross connected

Approval

Approval	Voltage Rating (V)	Current Rating (A)
UL	300	10

Part Number

Color	Part Number	Quantity (Pieces) per pack
Grey	10134295-004LF	25

Technical Information

Rated Cross Section (mm ²)	Level	Rigid Conductor (mm ²)	Flexible Conductor (mm ²)	Wire Gauge (AWG)	Dimension (Length x Height x Thickness) (mm)	Stripping Length (mm)	Screw	Tightening Torque
2.5	3	0.5-2.5	0.5-2.5	26-14	62 x 47.5 x 5	6	M2.5	0.5Nm/ 4.5 Lb-In

Accessories

Description	Part Number	Quantity (Pieces) per pack	Page
Marking Tags(5mm x 3mm)	10134398-001LF~ 10134398-041LF	100	87~88
Marking tags(5mm x 5.8mm)	10134402-001LF	500	89
End Bracket width 9mm	10134389-001LF	50	97
End Bracket width 6mm	10134390-001LF		97
Fast-snap End Bracket	10134391-001LF		97
End Plate	10134298-001LF	25	92
Jumper Bar pitch 5,1mm 2 poles - blue	10134414-001LF	100	100
Jumper Bar pitch 5,1mm 3 poles - blue	10134414-002LF	100	100
Jumper Bar pitch 5,1mm 12 poles - blue	10134414-003LF	10	100
Jumper Bar pitch 5,1mm 2 poles - red	10134414-004LF	100	100
Jumper Bar pitch 5,1mm 3 poles - red	10134414-005LF	100	100
Jumper Bar pitch 5,1mm 12 poles - red	10134414-006LF	10	100
Ratchet Cutting Tool for jumper bar	10134271-005LF	1	101

▶ SPRING CLAMP TERMINAL BLOCKS

The modular spring clamp terminal blocks solution is designed based on spring clamp technology to allow faster connection with reduced mounting time and maintenance cost. The spring design provides effortless wire insertion, making this solution easy to install.

The spring clamp terminal blocks solution is flexible and is suitable for a variety of applications with standard, multilevel and ground types. Conductor sizes ranges from 2.5mm² to 10.0mm².



TARGET MARKETS

- Control Cabinets for Machinery
- Control Cabinets for Buildings
- Power Distribution Cabinets
- Process Automation

Features

- Spring clamp technology
- Comprehensive range of wire cross section
- Compact design
- Large connection space
- Optimum guidance for the screwdriver
- Good contact stability – permanently
- Vibration resistance clamp
- RoHS compliant, lead-free, halogen-free

BENEFITS

- Reduces the mounting and maintenance cost; cost saving
- Complete product offering for all customer needs
- Space saving
- Enables rigid and flexible conductors
- Easy to install
- Maintenance-free
- Stable and durable connections
- Meets environmental, health and safety requirements

▶ SPRING CLAMP TERMINAL BLOCKS



2.5-4.0mm² - 630V - 32A

Approval

Approval	Voltage Rating (V)	Current Rating (A)
UL	600	20
VDE	630	24
Kema EX	II 2 GD EEx e II 03ATEX2118 U	

Part Number

Color	Part Number	Quantity (Pieces) per pack
Grey	10134336-001LF	50
Blue	10134336-002LF	

Technical Information

Rated Cross Section (mm ²)	Rigid Conductor (mm ²)	Flexible Conductor (mm ²)	Wire Gauge (AWG)	Dimension (Length x Height x Thickness) (mm)	Stripping Length (mm)
2.5-4.0	1.0-4.0	1.0-4.0	24-12	53 x 28.5 x 5	12

Accessories

Description	Part Number	Quantity (Pieces) per pack	Page
Marking Tags (4.8mm x 8.4mm)	10134397-001LF	500	87
Marking Tags (4.5mm x 12mm)	10134419-001LF		90
End Bracket width 9mm	10134389-001LF	50	97
End Bracket width 6mm	10134390-001LF		97
Fast-snap End Bracket	10134391-001LF		97
End Plate	10134342-001LF		93
Jumper Bar pitch 5,1mm 2 Poles	10134273-001LF	100	99
Jumper Bar pitch 5,1mm 3 Poles	10134273-002LF		99
Jumper Bar pitch 5,1mm 24 Poles	10134273-003LF	5	99
Ratchet Cutting Tool for jumper bar	10134271-001LF	1	101
Red Test Plug Adapter	10134276-001LF	10	96
Black Test Plug Adapter	10134276-002LF		96

▶ SPRING CLAMP TERMINAL BLOCKS



4.0-6.0mm² - 630V - 41A

Approval

Approval	Voltage Rating (V)	Current Rating (A)
UL	600	30
VDE	630	32
Kema EX	II 2 GD EEx e II 03ATEX2118 U	

Part Number

Color	Part Number	Quantity (Pieces) per pack
Grey	10134337-001LF	50
Blue	10134337-002LF	

Technical Information

Rated Cross Section (mm ²)	Rigid Conductor (mm ²)	Flexible Conductor (mm ²)	Wire Gauge (AWG)	Dimension (Length x Height x Thickness) (mm)	Stripping Length (mm)
4.0-6.0	1.5-6.0	1.5-6.0	24-10	58 x 34.5 x 6	15

Accessories

Description	Part Number	Quantity (Pieces) per pack	Page
Marking Tags (4.8mm x 8.4mm)	10134397-001LF	500	87
Marking Tags (4.5mm x 12mm)	10134419-001LF		90
End Bracket width 9mm	10134389-001LF	50	97
End Bracket width 6mm	10134390-001LF		97
Fast-snap End Bracket	10134391-001LF		97
End Plate	10134343-001LF		93
Jumper Bar pitch 6,1mm 2 Poles	10134272-001LF	100	99
Jumper Bar pitch 6,1mm 3 Poles	10134272-002LF		99
Jumper Bar pitch 6,1mm 24 Poles	10134272-003LF	5	99
Ratchet Cutting Tool for jumper bar	10134271-002LF	1	101
Red Test Plug Adapter	10134276-001LF	10	96
Black Test Plug Adapter	10134276-002LF		96

▶ SPRING CLAMP TERMINAL BLOCKS



6.0-10.0mm² - 630V - 57A

Approval

Approval	Voltage Rating (V)	Current Rating (A)
cULus	600	45

Part Number

Color	Part Number	Quantity (Pieces) per pack
Grey	10134338-001LF	50
Blue	10134338-002LF	

Technical Information

Rated Cross Section (mm ²)	Rigid Conductor (mm ²)	Flexible Conductor (mm ²)	Wire Gauge (AWG)	Dimension (Length x Height x Thickness) (mm)	Stripping Length (mm)
6.0-10.0	1.5-10.0	1.5-10.0	22-8	63 x 38.5 x 8	18

Accessories

Description	Part Number	Quantity (Pieces) per pack	Page
Marking Tags(4.8mm x 8.4mm)	10134397-001LF	500	87
Marking Tags(4.5mm x 12mm)	10134419-001LF		90
End Bracket width 9mm	10134389-001LF	50	97
End Bracket width 6mm	10134390-001LF		97
Fast-snap End Bracket	10134391-001LF		97
End Plate	10134344-001LF		93
Jumper Bar pitch 8,1mm 2 Poles	10134274-001LF	100	100
Jumper Bar pitch 8,1mm 3 Poles	10134274-002LF		100
Jumper Bar pitch 8,1mm 12 Poles	10134274-003LF	5	100
Ratchet Cutting Tool for jumper bar	10134271-004LF	1	101
Red Test Plug Adapter	10134276-001LF	10	96
Black Test Plug Adapter	10134276-002LF		96

▶ SPRING CLAMP MULTILEVEL TERMINAL BLOCKS



2.5-4.0mm² - 630V - 32A

Approval

Approval	Voltage Rating (V)	Current Rating (A)
UL	600	20
VDE	630	24
Kema EX	II 2 GD EEx e II 03ATEX2118 U	

Part Number

Color	Part Number	Quantity (Pieces) per pack
Grey	10134339-001LF	25
Blue	10134339-002LF	

Technical Information

Rated Cross Section (mm ²)	Level	Rigid Conductor (mm ²)	Flexible Conductor (mm ²)	Wire Gauge (AWG)	Dimension (Length x Height x Thickness) (mm)	Stripping Length (mm)
2.5-4.0	1+2	1.0-4.0	1.0-4.0	24-12	68.5 x 28.5 x 5	12

Accessories

Description	Part Number	Quantity (Pieces) per pack	Page
Marking Tags (4.8mm x 8.4mm)	10134397-001LF	500	87
Marking Tags (4.5mm x 12mm)	10134419-001LF		90
End Bracket width 9mm	10134389-001LF	50	97
End Bracket width 6mm	10134390-001LF		97
Fast-snap End Bracket	10134391-001LF		97
End Plate	10134347-001LF	25	93
Jumper Bar pitch 5,1mm 2 Poles	10134273-001LF	100	99
Jumper Bar pitch 5,1mm 3 Poles	10134273-002LF		99
Jumper Bar pitch 5,1mm 24 Poles	10134273-003LF	5	99
Ratchet Cutting Tool for jumper bar	10134271-001LF	1	101
Red Test Plug Adapter	10134276-001LF	10	96
Black Test Plug Adapter	10134276-002LF		96

▶ SPRING CLAMP MULTILEVEL TERMINAL BLOCKS



2.5-4.0mm² - 630V - 32A

Approval

Approval	Voltage Rating (V)	Current Rating (A)
UL	600	20
VDE	630	24
Kema EX	II 2 GD EEx e II 03ATEX2118 U	

Part Number

Color	Part Number	Quantity (Pieces) per pack
Grey	10134340-001LF	25
Blue	10134340-002LF	

Technical Information

Rated Cross Section (mm ²)	Level	Rigid Conductor (mm ²)	Flexible Conductor (mm ²)	Wire Gauge (AWG)	Dimension (Length x Height x Thickness) (mm)	Stripping Length (mm)
2.5-4.0	2+2	1.0-4.0	1.0-4.0	24-12	87.5 x 28.5 x 5	12

Accessories

Description	Part Number	Quantity (Pieces) per pack	Page
Marking Tags (4.8mm x 8.4mm)	10134397-001LF	500	87
Marking Tags (4.5mm x 12mm)	10134419-001LF		90
End Bracket width 9mm	10134389-001LF	50	97
End Bracket width 6mm	10134390-001LF		97
Fast-snap End Bracket	10134391-001LF		97
End Plate	10134346-001LF	25	93
Jumper Bar pitch 5,1mm 2 Poles	10134273-001LF	100	99
Jumper Bar pitch 5,1mm 3 Poles	10134273-002LF		99
Jumper Bar pitch 5,1mm 24 Poles	10134273-003LF	5	99
Ratchet Cutting Tool for jumper bar	10134271-001LF	1	101
Red Test Plug Adapter	10134276-001LF	10	96
Black Test Plug Adapter	10134276-002LF		96

▶ SPRING CLAMP MULTILEVEL TERMINAL BLOCKS



2.5-4.0mm² - 630V - 32A

Approval

Approval	Voltage Rating (V)	Current Rating (A)
UL	600	20
VDE	630	24
Kema EX	II 2 GD EEx e II 03ATEX2118 U	

Part Number

Color	Part Number	Quantity (Pieces) per pack
Grey	10134341-001LF	25
Blue	10134341-002LF	

Technical Information

Rated Cross Section (mm ²)	Level	Rigid Conductor (mm ²)	Flexible Conductor (mm ²)	Wire Gauge (AWG)	Dimension (Length x Height x Thickness) (mm)	Stripping Length (mm)
2.5-4.0	2 x 2	1.0-4.0	1.0-4.0	24-12	98 x 37.5 x 5	12

Accessories

Description	Part Number	Quantity (Pieces) per pack	Page
Marking Tags (4.8mm x 8.4mm)	10134397-001LF	500	87
Marking Tags (4.5mm x 12mm)	10134419-001LF		90
End Bracket width 9mm	10134389-001LF	50	97
End Bracket width 6mm	10134390-001LF		97
Fast-snap End Bracket	10134391-001LF		97
End Plate	10134345-001LF	25	93
Jumper Bar pitch 5,1mm 2 Poles	10134273-001LF	100	99
Jumper Bar pitch 5,1mm 3 Poles	10134273-002LF		99
Jumper Bar pitch 5,1mm 24 Poles	10134273-003LF	5	99
Ratchet Cutting Tool for jumper bar	10134271-001LF	1	101
Red Test Plug Adapter	10134276-001LF	10	96
Black Test Plug Adapter	10134276-002LF		96

▶ SPRING CLAMP MULTILEVEL TERMINAL BLOCKS



2.5-4.0mm² - 630V - 32A, Unipolar

Approval

Approval	Voltage Rating (V)	Current Rating (A)
UL	600	20
VDE	630	24
Kema EX	II 2 GD EEx e II 03ATEX2118 U	

Part Number

Color	Part Number	Quantity (Pieces) per pack
Grey	10134341-006LF	10
Blue	10134341-007LF	

Technical Information

Rated Cross Section (mm ²)	Level	Rigid Conductor (mm ²)	Flexible Conductor (mm ²)	Wire Gauge (AWG)	Dimension (Length x Height x Thickness) (mm)	Stripping Length (mm)
2.5-4.0	2 x 2	1.0-4.0	1.0-4.0	24-12	98 x 37.5 x 5	12

Accessories

Description	Part Number	Quantity (Pieces) per pack	Page
Marking Tags (4.8mm x 8.4mm)	10134397-001LF	500	87
Marking Tags (4.5mm x 12mm)	10134419-001LF		90
End Bracket width 9mm	10134389-001LF	50	97
End Bracket width 6mm	10134390-001LF		97
Fast-snap End Bracket	10134391-001LF		97
End Plate	10134345-001LF	25	93
Jumper Bar pitch 5,1mm 2 Poles	10134273-001LF	100	99
Jumper Bar pitch 5,1mm 3 Poles	10134273-002LF		99
Jumper Bar pitch 5,1mm 24 Poles	10134273-003LF	5	99
Ratchet Cutting Tool for jumper bar	10134271-001LF	1	101
Red Test Plug Adapter	10134276-001LF	10	96
Black Test Plug Adapter	10134276-002LF		96

▶ SPRING CLAMP GROUND TERMINAL BLOCKS



2.5-4.0mm²

Approval

Approval	Voltage Rating (V)	Current Rating (A)
UL	/	
VDE	/	
Kema EX	II 2 GD EEx e II 03ATEX2118 U	

Part Number

Color	Part Number	Quantity (Pieces) per pack
Yellow Green	10134348-001LF	50

Technical Information

Rated Cross Section (mm ²)	Level	Rigid Conductor (mm ²)	Flexible Conductor (mm ²)	Wire Gauge (AWG)	Dimension (Length x Height x Thickness) (mm)	Stripping Length (mm)
2.5-4.0	1	1.0-4.0	1.0-4.0	24-12	53 x 28.5 x 5	12

Accessories

Description	Part Number	Quantity (Pieces) per pack	Page
Marking Tags (4.8mm x 8.4mm)	10134397-001LF	500	87
Marking Tags (4.5mm x 12mm)	10134419-001LF		90
End Bracket width 9mm	10134389-001LF	50	97
End Bracket width 6mm	10134390-001LF		97
Fast-snap End Bracket	10134391-001LF		97
End Plate	10134342-001LF		93

▶ SPRING CLAMP GROUND TERMINAL BLOCKS



4.0-6.0mm²

Approval

Approval	Voltage Rating (V)	Current Rating (A)
UL	/	
VDE	/	
Kema EX	II 2 GD EEx e II 03ATEX2118 U	

Part Number

Color	Part Number	Quantity (Pieces) per pack
Yellow Green	10134349-001LF	50

Technical Information

Rated Cross Section (mm ²)	Level	Rigid Conductor (mm ²)	Flexible Conductor (mm ²)	Wire Gauge (AWG)	Dimension (Length x Height x Thickness) (mm)	Stripping Length (mm)
4.0-6.0	1	1.5-6.0	1.5-6.0	24-10	58 x 34.5 x 6	15

Accessories

Description	Part Number	Quantity (Pieces) per pack	Page
Marking Tags (4.8mm x 8.4mm)	10134397-001LF	500	87
Marking Tags (4.5mm x 12mm)	10134419-001LF		90
End Bracket width 9mm	10134389-001LF	50	97
End Bracket width 6mm	10134390-001LF		97
Fast-snap End Bracket	10134391-001LF		97
End Plate	10134343-001LF		93

▶ SPRING CLAMP GROUND TERMINAL BLOCKS



6.0-10.0mm²

Approval

Approval	Voltage Rating (V)	Current Rating (A)
cULus		/

Part Number

Color	Part Number	Quantity (Pieces) per pack
Yellow Green	10134350-001LF	50

Technical Information

Rated Cross Section (mm ²)	Level	Rigid Conductor (mm ²)	Flexible Conductor (mm ²)	Wire Gauge (AWG)	Dimension (Length x Height x Thickness) (mm)	Stripping Length (mm)
6.0-10.0	1	1.5-10.0	1.5-10.0	22-8	63 x 38.5 x 8	18

Accessories

Description	Part Number	Quantity (Pieces) per pack	Page
Marking Tags(4.8mm x 8.4mm)	10134397-001LF	500	87
Marking Tags(4.5mm x 12mm)	10134419-001LF		90
End Bracket width 9mm	10134389-001LF	50	97
End Bracket width 6mm	10134390-001LF		97
Fast-snap End Bracket	10134391-001LF		97
End Plate	10134344-001LF		93

▶ SPRING CLAMP GROUND TERMINAL BLOCKS

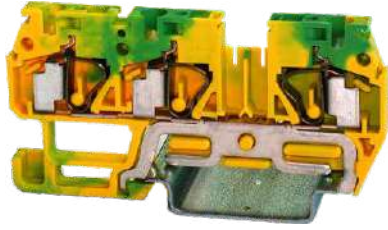

2.5-4.0mm²

Approval

Approval	Voltage Rating (V)	Current Rating (A)
cULus		/

Part Number

Color	Part Number	Quantity (Pieces) per pack
Yellow Green	10134351-001LF	25

Technical Information

Rated Cross Section (mm ²)	Level	Rigid Conductor (mm ²)	Flexible Conductor (mm ²)	Wire Gauge (AWG)	Dimension (Length x Height x Thickness) (mm)	Stripping Length (mm)
2.5-4.0	1+2	1.0-4.0	1.0-4.0	24-12	68.5 x 28.5 x 5	12

Accessories

Description	Part Number	Quantity (Pieces) per pack	Page
Marking Tags(4.8mm x 8.4mm)	10134397-001LF	500	87
Marking Tags(4.5mm x 12mm)	10134419-001LF		90
End Bracket width 9mm	10134389-001LF	50	97
End Bracket width 6mm	10134390-001LF		97
Fast-snap End Bracket	10134391-001LF		97
End Plate	10134347-001LF		93

▶ SPRING CLAMP GROUND TERMINAL BLOCKS

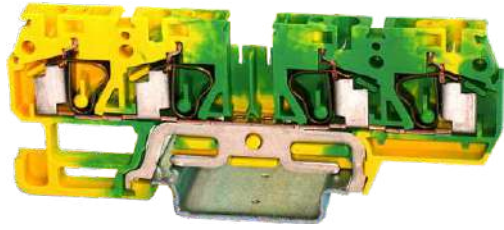

2.5-4.0mm²

Approval

Approval	Voltage Rating (V)	Current Rating (A)
cULus		/

Part Number

Color	Part Number	Quantity (Pieces) per pack
Yellow Green	10134352-001LF	25

Technical Information

Rated Cross Section (mm ²)	Level	Rigid Conductor (mm ²)	Flexible Conductor (mm ²)	Wire Gauge (AWG)	Dimension (Length x Height x Thickness) (mm)	Stripping Length (mm)
2.5-4.0	2+2	1.0-4.0	1.0-4.0	24-12	87.5 x 28.5 x 5	12

Accessories

Description	Part Number	Quantity (Pieces) per pack	Page
Marking Tags(4.8mm x 8.4mm)	10134397-001LF	500	87
Marking Tags(4.5mm x 12mm)	10134419-001LF		90
End Bracket width 9mm	10134389-001LF	50	97
End Bracket width 6mm	10134390-001LF		97
Fast-snap End Bracket	10134391-001LF		97
End Plate	10134346-001LF		93

▶ PLUGGABLE TERMINAL BLOCKS

The modular pluggable system allows quick installation. It is a cost effective solution designed for increasing productivity with PCB pluggable terminal blocks. This allows connection with multiple wires instead of one-to-one, thereby reducing mounting time required.

The pluggable solution is flexible and includes screw and spring clamp terminal blocks with conductor size 2.5mm² and current rating up to 24A.

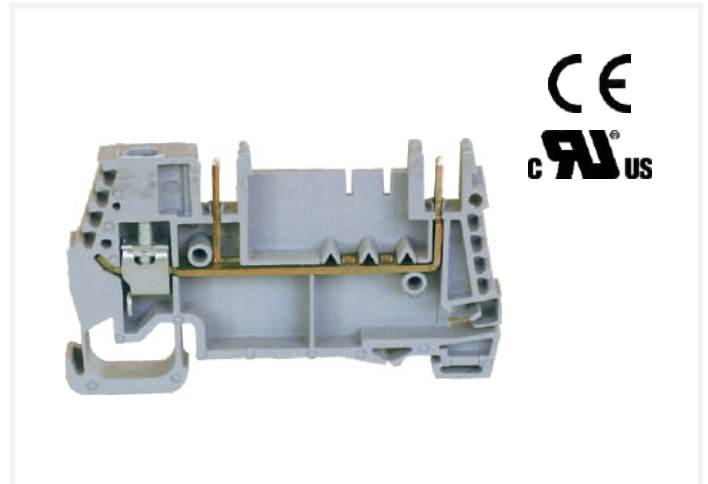

TARGET MARKETS

- Control Cabinets for Machinery
- Control Cabinets for Buildings
- Power Distribution Cabinets
- Process Automation

Features

- Simple fuse protection
- Compact design
- Large connection space
- Flexible and comprehensive range of accessories
- Optimum guidance for the screwdriver
- Good contact stability – permanently
- Vibration resistance clamp
- RoHS compliant, lead-free and halogen-free

BENEFITS

- Easy to apply and protection guaranteed
- Space saving
- Enables rigid and flexible conductors
- One solution for all needs
- Easy to install
- Maintenance-free
- Guarantees a gas-tight contact point and high contact force
- Meets environmental, health and safety requirements

► SCREW PLUGGABLE TERMINAL BLOCKS

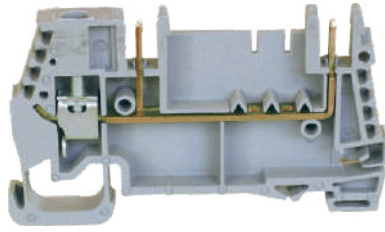

2.5mm² - 400V - 24A(2x12A)

Approval

Approval	Voltage Rating (V)	Current Rating (A)
cULus	300	20A(2 x 10A) - 12A

Part Number

Color	Part Number	Quantity (Pieces) per pack
Grey	10134354-001LF	32
Blue	10134354-002LF	
Yellow Green	10134354-003LF	

Technical Information

Rated Cross Section (mm ²)	Level	Rigid Conductor (mm ²)	Flexible Conductor (mm ²)	Wire Gauge (AWG)	Dimension (Length x Height x Thickness) (mm)	Stripping Length (mm)	Screw	Tightening Torque
2.5	1	0.5-2.5	0.5-2.5	24-12	59 x 29.5 x 5	8	M2.6	0.5Nm/ 4.0 Lb-In

Accessories

Description	Part Number	Quantity (Pieces) per pack	Page
Marking Tags(5mm x 3mm)	10134398-001LF~ 10134398-041LF	100	87~88
Marking Tags(5mm x 12mm)	10134400-001LF	500	89
End Bracket width 9mm	10134389-001LF	50	97
End Bracket width 6mm	10134390-001LF		97
Fast-snap End Bracket	10134391-001LF		97
End Plate	10134360-001LF	25	94
Spacer	10134363-001LF		94
Jumper Bar pitch 5,1mm 2 Poles	10134273-001LF	100	99
Jumper Bar pitch 5,1mm 3 Poles	10134273-002LF		99
Jumper Bar pitch 5,1mm 24 Poles	10134273-003LF	5	99
Ratchet Cutting Tool for jumper bar	10134271-001LF	1	101
Red Test Plug Adapter	10134276-001LF	10	96
Black Test Plug Adapter	10134276-002LF		96
Female terminal block, pitch 5.08mm	10134365-001LF~ 10134365-011LF	/	46

► SCREW PLUGGABLE TERMINAL BLOCKS

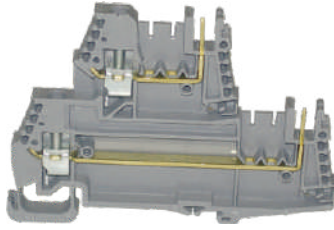

2.5mm² - 400V - 12A

Approval

Approval	Voltage Rating (V)	Current Rating (A)
cULus	300	12

Part Number

Color	Part Number	Quantity (Pieces) per pack
Grey	10134355-001LF	32
Blue	10134355-002LF	
Yellow Green	10134355-003LF	

Technical Information

Rated Cross Section (mm ²)	Level	Rigid Conductor (mm ²)	Flexible Conductor (mm ²)	Wire Gauge (AWG)	Dimension (Length x Height x Thickness) (mm)	Stripping Length (mm)	Screw	Tightening Torque
2.5	2	0.5-2.5	0.5-2.5	24-12	77 x 52 x 5	8	M2.6	0.5Nm/ 4.0 Lb-In

Accessories

Description	Part Number	Quantity (Pieces) per pack	Page
Marking Tags(5mm x 3mm)	10134398-001LF~ 10134398-041LF	100	87~88
Marking Tags(5mm x 12mm)	10134400-001LF	500	89
End Bracket width 9mm	10134389-001LF	50	97
End Bracket width 6mm	10134390-001LF		97
Fast-snap End Bracket	10134391-001LF		97
End Plate	10134361-001LF	25	94
Spacer	10134364-001LF		94
Jumper Bar pitch 5,1mm 2 Poles	10134273-001LF	100	99
Jumper Bar pitch 5,1mm 3 Poles	10134273-002LF		99
Jumper Bar pitch 5,1mm 24 Poles	10134273-003LF	5	99
Ratchet Cutting Tool for jumper bar	10134271-001LF	1	101
Red Test Plug Adapter	10134276-001LF	10	96
Black Test Plug Adapter	10134276-002LF		96
Female terminal block, pitch 5.08mm	10134365-001LF~ 10134365-011LF	/	46

► SCREW PLUGGABLE TERMINAL BLOCKS

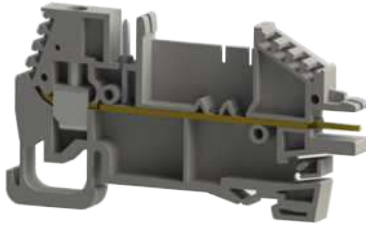

2.5mm² - 400V - 24A(2x12A)

Approval

Approval	Voltage Rating (V)	Current Rating (A)
cULus	300	20A(2 x 10A) - 12A

Part Number

Color	Part Number	Quantity (Pieces) per pack
Grey	10134356-001LF	32
Blue	10134356-002LF	
Yellow Green	10134356-003LF	

Technical Information

Rated Cross Section (mm ²)	Level	Rigid Conductor (mm ²)	Flexible Conductor (mm ²)	Wire Gauge (AWG)	Dimension (Length x Height x Thickness) (mm)	Stripping Length (mm)	Screw	Tightening Torque
2.5	1	0.5-2.5	0.5-2.5	24-12	65 x 29.5 x 5	8	M2.6	0.5Nm/ 4.0 Lb-In

Accessories

Description	Part Number	Quantity (Pieces) per pack	Page
Marking Tags(5mm x 3mm)	10134398-001LF~ 10134398-041LF	100	87~88
Marking Tags(5mm x 12mm)	10134400-001LF	500	89
End Bracket width 9mm	10134389-001LF	50	97
End Bracket width 6mm	10134390-001LF		97
Fast-snap End Bracket	10134391-001LF		97
End Plate	10134362-001LF	25	94
Spacer	10134421-001LF		94
Jumper Bar pitch 5,1mm 2 Poles	10134273-001LF	100	99
Jumper Bar pitch 5,1mm 3 Poles	10134273-002LF		99
Jumper Bar pitch 5,1mm 24 Poles	10134273-003LF	5	99
Ratchet Cutting Tool for jumper bar	10134271-001LF	1	101
Red Test Plug Adapter	10134276-001LF	10	96
Black Test Plug Adapter	10134276-002LF		96
Female terminal block, pitch 5.08mm	10134365-001LF~ 10134365-011LF	/	46

▶ SPRING CLAMP PLUGGABLE TERMINAL BLOCKS



2.5mm² - 400V - 24A(2x12A)

Approval

Approval	Voltage Rating (V)	Current Rating (A)
cULus	300	20A(2 x 10A) - 12A

Part Number

Color	Part Number	Quantity (Pieces) per pack
Grey	10134357-001LF	32
Blue	10134357-002LF	
Yellow Green	10134357-003LF	

Technical Information

Rated Cross Section (mm ²)	Level	Rigid Conductor (mm ²)	Flexible Conductor (mm ²)	Wire Gauge (AWG)	Dimension (Length x Height x Thickness) (mm)	Stripping Length (mm)
2.5	1	0.5-2.5	0.5-2.5	24-12	59x29.5 x 5	8

Accessories

Description	Part Number	Quantity (Pieces) per pack	Page
Marking Tags(5mm x 3mm)	10134398-001LF~ 10134398-041LF	100	87~88
Marking Tags(5mm x 12mm)	10134400-001LF	500	89
End Bracket width 9mm	10134389-001LF	50	97
End Bracket width 6mm	10134390-001LF		97
Fast-snap End Bracket	10134391-001LF		97
End Plate	10134360-001LF	25	94
Spacer	10134363-001LF		94
Jumper Bar pitch 5,1mm 2 Poles	10134273-001LF	100	99
Jumper Bar pitch 5,1mm 3 Poles	10134273-002LF		99
Jumper Bar pitch 5,1mm 24 Poles	10134273-003LF	5	99
Ratchet Cutting Tool for jumper bar	10134271-001LF	1	101
Red Test Plug Adapter	10134276-001LF	10	96
Black Test Plug Adapter	10134276-002LF		96
Female terminal block, pitch 5.08mm	10134365-001LF~ 10134365-011LF	/	46

▶ SPRING CLAMP PLUGGABLE TERMINAL BLOCKS



2.5mm² - 400V - 12A

Approval

Approval	Voltage Rating (V)	Current Rating (A)
cULus	300	12

Part Number

Color	Part Number	Quantity (Pieces) per pack
Grey	10134358-001LF	32
Blue	10134358-002LF	
Yellow Green	10134358-003LF	

Technical Information

Rated Cross Section (mm ²)	Level	Rigid Conductor (mm ²)	Flexible Conductor (mm ²)	Wire Gauge (AWG)	Dimension (Length x Height x Thickness) (mm)	Stripping Length (mm)
2.5	2	0.5-2.5	0.5-2.5	24-12	77 x 52 x 5	8

Pluggable Terminal Blocks

Accessories

Description	Part Number	Quantity (Pieces) per pack	Page
Marking Tags (5mm x 3mm)	10134398-001LF~ 10134398-041LF	100	87~88
Marking Tags (5mm x 12mm)	10134400-001LF	500	89
End Bracket width 9mm	10134389-001LF	50	97
End Bracket width 6mm	10134390-001LF		97
Fast-snap End Bracket	10134391-001LF		97
End Plate	10134361-001LF	25	94
Spacer	10134364-001LF		94
Jumper Bar pitch 5,1mm 2 Poles	10134273-001LF	100	99
Jumper Bar pitch 5,1mm 3 Poles	10134273-002LF		99
Jumper Bar pitch 5,1mm 24 Poles	10134273-003LF	5	99
Ratchet Cutting Tool for jumper bar	10134271-001LF	1	101
Red Test Plug Adapter	10134276-001LF	10	96
Black Test Plug Adapter	10134276-002LF		96
Female terminal block, pitch 5.08mm	10134365-001LF~ 10134365-011LF	/	46

▶ SPRING CLAMP PLUGGABLE TERMINAL BLOCKS

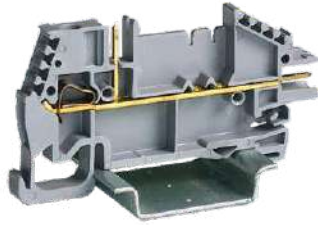

2.5mm² - 400V - 24A(2x12A)

Approval

Approval	Voltage Rating (V)	Current Rating (A)
cULus	300	20A(2 x 10A) - 12A

Part Number

Color	Part Number	Quantity (Pieces) per pack
Grey	10134359-001LF	32
Blue	10134359-002LF	
Yellow Green	10134359-003LF	

Technical Information

Rated Cross Section (mm ²)	Level	Rigid Conductor (mm ²)	Flexible Conductor (mm ²)	Wire Gauge (AWG)	Dimension (Length x Height x Thickness) (mm)	Stripping Length (mm)
2.5	1	0.5-2.5	0.5-2.5	24-12	65 x 29.5 x 5	8

Accessories

Description	Part Number	Quantity (Pieces) per pack	Page
Marking Tags(5mm x 3mm)	10134398-001LF~ 10134398-041LF	100	87~88
Marking Tags(5mm x 12mm)	10134400-001LF	500	89
End Bracket width 9mm	10134389-001LF	50	97
End Bracket width 6mm	10134390-001LF		97
Fast-snap End Bracket	10134391-001LF		97
End Plate	10134362-001LF	25	94
Spacer	10134421-001LF		94
Jumper Bar pitch 5,1mm 2 Poles	10134273-001LF	100	99
Jumper Bar pitch 5,1mm 3 Poles	10134273-002LF		99
Jumper Bar pitch 5,1mm 24 Poles	10134273-003LF	5	99
Ratchet Cutting Tool for jumper bar	10134271-001LF	1	101
Red Test Plug Adapter	10134276-001LF	10	96
Black Test Plug Adapter	10134276-002LF		96
Female terminal block, pitch 5.08mm	10134365-001LF~ 10134365-011LF	/	46

▶ FEMALE TERMINAL BLOCKS



2.5mm² - 400V - 12A, 90°

Approval

Approval	Voltage Rating (V)	Current Rating (A)
UL	300	12

Part Number

Color	Part Number	Poles	Quantity (Pieces) per pack
Green	10134365-001LF	2	200
Green	10134365-002LF	3	
Green	10134365-003LF	4	100
Green	10134365-004LF	5	
Green	10134365-005LF	6	
Green	10134365-006LF	7	50
Green	10134365-007LF	8	
Green	10134365-008LF	9	
Green	10134365-009LF	10	
Green	10134365-010LF	11	
Green	10134365-011LF	12	

Technical Information

Rated Cross Section (mm ²)	Rigid Conductor (mm ²)	Flexible Conductor (mm ²)	Wire Gauge (AWG)	Pitch	Dimension (Length x Height x Thickness) (mm)	Stripping Length (mm)	Screw	Tightening Torque
2.5	0.5-2.5	0.5-2.5	22-14	5.08	(5.08 x poles) x 14.5 x 19.3	7	M3	0.5Nm/ 4.5 Lb-In.

Pluggable Terminal Blocks

UNIVERSAL TERMINAL BLOCKS

The universal terminal blocks system is a flexible and comprehensive solution designed for multiple purpose use.

The universal terminal blocks is equipped with protective, disconnecting and blocking devices and provides protection against short circuit or for disconnecting devices having utilities like instrument or associated transformers.

The modular and compact design makes the universal solution very suitable for applications with conductor sizes ranging from 2.5mm² to 4.0mm².



TARGET MARKETS

- Control Cabinets for Machinery
- Control Cabinets for Buildings
- Power Distribution Cabinets
- Process Automation

Features

- Universal terminal blocks can be equipped with protective, disconnecting and blocking devices
- Disconnecting technology
- Compact design
- Large connection space
- Optimum guidance for the screwdriver
- Good contact stability – permanently
- RoHS compliant, lead-free, halogen-free

BENEFITS

- Comprehensive product offering for all the customer needs
- Open circuit without disconnecting the conductor
- Space saving
- Enables rigid and flexible conductors
- Easy to install
- Maintenance-free
- Meets environmental, health and safety requirements

► SCREW UNIVERSAL TERMINAL BLOCKS

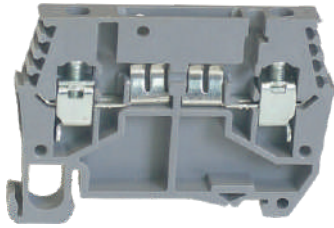

2.5mm² - 300V - 20A

Part Number

Approval

Approval	Voltage Rating (V)	Current Rating (A)
cULus	300	20

Color	Part Number	Quantity (Pieces) per pack
Grey	10134366-001LF	50

Technical Information

Rated Cross Section (mm ²)	Rigid Conductor (mm ²)	Flexible Conductor (mm ²)	Wire Gauge (AWG)	Dimension (Length x Height x Thickness) (mm)	Stripping Length (mm)	Screw	Tightening Torque
2.5	0.5-2.5	0.5-2.5	24-12	55 x 34 x 5	9	M2.6	0.5Nm/ 4.5 Lb-In

Accessories

Description	Part Number	Quantity (Pieces) per pack	Page
Marking Tags(5mm x 3mm)	10134398-001LF~ 10134398-041LF	100	87~88
Marking Tags(5mm x 12mm)	10134400-001LF	500	89
End Bracket width 9mm	10134389-001LF	50	97
End Bracket width 6mm	10134390-001LF		97
Fast-snap End Bracket	10134391-001LF		97
End Plate	10134378-001LF		95
Separator	10134378-002LF		95

► SCREW UNIVERSAL TERMINAL BLOCKS

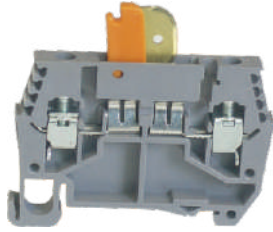

2.5mm² - 300V - 20A, Disconnecter

Part Number

Approval

Approval	Voltage Rating (V)	Current Rating (A)
cULus	300	20

Color	Part Number	Quantity (Pieces) per pack
Grey	10134368-001LF	50

Technical Information

Rated Cross Section (mm ²)	Rigid Conductor (mm ²)	Flexible Conductor (mm ²)	Wire Gauge (AWG)	Dimension (Length x Height x Thickness) (mm)	Stripping Length (mm)	Screw	Tightening Torque
2.5	0.5-2.5	0.5-2.5	24-12	55 x 34 x 5	9	M2.6	0.5Nm/ 4.5 Lb-In

Accessories

Description	Part Number	Quantity (Pieces) per pack	Page
Marking Tags(5mm x 3mm)	10134398-001LF~ 10134398-041LF	100	87~88
Marking Tags(5mm x 12mm)	10134400-001LF	500	89
End Bracket width 9mm	10134389-001LF	50	97
End Bracket width 6mm	10134390-001LF		97
Fast-snap End Bracket	10134391-001LF		97
End Plate	10134378-001LF		95
Separator	10134378-002LF		95

► SCREW UNIVERSAL TERMINAL BLOCKS



4mm² - 300V - 25A

Part Number

Approval

Approval	Voltage Rating (V)	Current Rating (A)
cULus	300	25

Color	Part Number	Quantity (Pieces) per pack
Grey	10134370-001LF	50

Technical Information

Rated Cross Section (mm ²)	Rigid Conductor (mm ²)	Flexible Conductor (mm ²)	Wire Gauge (AWG)	Dimension (Length x Height x Thickness) (mm)	Stripping Length (mm)	Screw	Tightening Torque
4.0	0.5-4.0	0.5-4.0	24-10	55 x 34 x 6	9	M3	0.6Nm/ 7 Lb-In

Accessories

Description	Part Number	Quantity (Pieces) per pack	Page
Marking Tags(5mm x 3mm)	10134398-001LF~ 10134398-041LF	100	87~88
Marking Tags(5mm x 12mm)	10134400-001LF	500	89
Marking Tags(6mm x 12mm)	10134401-001LF	500	89
End Bracket width 9mm	10134389-001LF	50	97
End Bracket width 6mm	10134390-001LF		97
Fast-snap End Bracket	10134391-001LF		97
End Plate	10134378-001LF		95
Separator	10134378-002LF		95
Jumper Bar pitch 9,1mm 12 poles	10134420-001LF	10	100
Ratchet Cutting Tool for jumper bar	10134271-003LF	1	101

► SCREW UNIVERSAL TERMINAL BLOCKS



4mm² - 300V - 25A, Disconnecter

Part Number

Approval

Approval	Voltage Rating (V)	Current Rating (A)
cULus	300	25

Color	Part Number	Quantity (Pieces) per pack
Grey	10134371-001LF	50

Technical Information

Rated Cross Section (mm ²)	Rigid Conductor (mm ²)	Flexible Conductor (mm ²)	Wire Gauge (AWG)	Dimension (Length x Height x Thickness) (mm)	Stripping Length (mm)	Screw	Tightening Torque
4.0	0.5-4.0	0.5-4.0	24-10	55 x 34 x 6	9	M3	0.6Nm/ 7 Lb-In

Accessories

Description	Part Number	Quantity (Pieces) per pack	Page
Marking Tags(5mm x 3mm)	10134398-001LF~ 10134398-041LF	100	87~88
Marking Tags(5mm x 12mm)	10134400-001LF	500	89
Marking Tags(6mm x 12mm)	10134401-001LF	500	89
End Bracket width 9mm	10134389-001LF	50	97
End Bracket width 6mm	10134390-001LF		97
Fast-snap End Bracket	10134391-001LF		97
End Plate	10134378-001LF		95
Separator	10134378-002LF		95

► SCREW UNIVERSAL TERMINAL BLOCKS



4mm² - 500V - 30A

Part Number

Color	Part Number	Quantity (Pieces) per pack
Grey	10134300-001LF	50

Approval

Approval	Voltage Rating (V)	Current Rating (A)
UL	300	15

Technical Information

Rated Cross Section (mm ²)	Rigid Conductor (mm ²)	Flexible Conductor (mm ²)	Wire Gauge (AWG)	Dimension (Length x Height x Thickness) (mm)	Stripping Length (mm)	Screw	Tightening Torque
4.0	0.5-6.0	0.5-4.0	24-10	66 x 44 x 10.5	10	M3	0.6Nm/ 7.0 Lb-In

Accessories

Description	Part Number	Quantity (Pieces) per pack	Page
Marking Tags(5mm x 3mm)	10134398-001LF~ 10134398-041LF	100	87~88
Marking Tags(5mm x 12mm)	10134400-001LF	500	89
End Bracket width 9mm	10134389-001LF	50	97
End Bracket width 6mm	10134390-001LF		97
Fast-snap End Bracket	10134391-001LF		97

▶ SPRING CLAMP UNIVERSAL TERMINAL BLOCKS



2.5mm² - 300V - 20A

Part Number

Approval

Approval	Voltage Rating (V)	Current Rating (A)
cULus	300	20

Color	Part Number	Quantity (Pieces) per pack
Grey	10134367-001LF	50

Technical Information

Rated Cross Section (mm ²)	Rigid Conductor (mm ²)	Flexible Conductor (mm ²)	Wire Gauge (AWG)	Dimension (Length x Height x Thickness) (mm)	Stripping Length (mm)
2.5	0.5-2.5	0.5-2.5	24-12	55 x 34 x 5	9

Accessories

Description	Part Number	Quantity (Pieces) per pack	Page
Marking Tags(5mm x 3mm)	10134398-001LF~ 10134398-041LF	100	87~88
Marking Tags(5mm x 12mm)	10134400-001LF	500	89
End Bracket width 9mm	10134389-001LF	50	97
End Bracket width 6mm	10134390-001LF		97
Fast-snap End Bracket	10134391-001LF		97
End Plate	10134378-001LF		95
Separator	10134378-002LF		95

▶ SPRING CLAMP UNIVERSAL TERMINAL BLOCKS



2.5mm² - 300V - 20A, Disconnecter

Part Number

Approval

Approval	Voltage Rating (V)	Current Rating (A)
cULus	300	20

Color	Part Number	Quantity (Pieces) per pack
Grey	10134369-001LF	50

Technical Information

Rated Cross Section (mm ²)	Rigid Conductor (mm ²)	Flexible Conductor (mm ²)	Wire Gauge (AWG)	Dimension (Length x Height x Thickness) (mm)	Stripping Length (mm)
2.5	0.5-2.5	0.5-2.5	24-12	55 x 34 x 5	9

Accessories

Description	Part Number	Quantity (Pieces) per pack	Page
Marking Tags(5mm x 3mm)	10134398-001LF~ 10134398-041LF	100	87~88
Marking Tags(5mm x 12mm)	10134400-001LF	500	89
End Bracket width 9mm	10134389-001LF	50	97
End Bracket width 6mm	10134390-001LF		97
Fast-snap End Bracket	10134391-001LF		97
End Plate	10134378-001LF		95
Separator	10134378-002LF		95

▶ SPRING CLAMP UNIVERSAL TERMINAL BLOCKS



4mm² - 300V - 25A

Part Number

Approval

Approval	Voltage Rating (V)	Current Rating (A)
cULus	300	25

Color	Part Number	Quantity (Pieces) per pack
Grey	10134372-001LF	50

Technical Information

Rated Cross Section (mm ²)	Rigid Conductor (mm ²)	Flexible Conductor (mm ²)	Wire Gauge (AWG)	Dimension (Length x Height x Thickness) (mm)	Stripping Length (mm)
4.0	0.5-4.0	0.5-4.0	24-10	55 x 34 x 6	9

Accessories

Description	Part Number	Quantity (Pieces) per pack	Page
Marking Tags(5mm x 3mm)	10134398-001LF~ 10134398-041LF	100	87~88
Marking Tags(5mm x 12mm)	10134400-001LF	500	89
Marking Tags(6mm x 12mm)	10134401-001LF	500	89
End Bracket width 9mm	10134389-001LF	50	97
End Bracket width 6mm	10134390-001LF		97
Fast-snap End Bracket	10134391-001LF		97
End Plate	10134378-001LF		95
Separator	10134378-002LF		95
Jumper Bar pitch 9,1mm 12 poles	10134420-001LF	10	100
Ratchet Cutting Tool for jumper bar	10134271-003LF	1	101

▶ SPRING CLAMP UNIVERSAL TERMINAL BLOCKS



4mm² - 300V - 25A, Disconnecter

Part Number

Approval

Approval	Voltage Rating (V)	Current Rating (A)
cULus	300	25

Color	Part Number	Quantity (Pieces) per pack
Grey	10134373-001LF	50

Technical Information

Rated Cross Section (mm ²)	Rigid Conductor (mm ²)	Flexible Conductor (mm ²)	Wire Gauge (AWG)	Dimension (Length x Height x Thickness) (mm)	Stripping Length (mm)
4.0	0.5-4.0	0.5-4.0	24-10	55 x 34 x 6	9



Accessories

Description	Part Number	Quantity (Pieces) per pack	Page
Marking Tags(5mm x 3mm)	10134398-001LF~ 10134398-041LF	100	87~88
Marking Tags(5mm x 12mm)	10134400-001LF	500	89
Marking Tags(6mm x 12mm)	10134401-001LF	500	89
End Bracket width 9mm	10134389-001LF	50	97
End Bracket width 6mm	10134390-001LF		97
Fast-snap End Bracket	10134391-001LF		97
End Plate	10134378-001LF		95
Separator	10134378-002LF		95



▶ EQUIPMENT(ACCESSORIES)

Equipment Type	Dimension (Length x Height x Thickness) (mm)	Color	Voltage Rating (V)	Current Rating (A)	Part Number	Quantity (Pieces) per pack
	19.2 x 20.4 x 5	Orange	-	25	10134379-001LF	20
	18.9 x 13.7 x 5.3	Black	32	1	10134382-001LF	20
		Grey	32	2	10134382-002LF	
		Violet	32	3	10134382-003LF	
		Pink	32	4	10134382-004LF	
		Beige	32	5	10134382-005LF	
		Brown	32	7.5	10134382-006LF	
		Red	32	10	10134382-007LF	
		Blue	32	15	10134382-008LF	
		Yellow	32	20	10134382-009LF	
		White	32	25	10134382-010LF	
		Green	32	30	10134382-011LF	
	20.3 x 24 x 6	Green	12VDC	6	10134383-001LF	20
		Yellow	12VDC	8	10134383-002LF	
		Red	12VDC	10	10134383-003LF	
		Blue	12VDC	15	10134383-004LF	
		White	12VDC	25	10134383-005LF	

► EQUIPMENT(ACCESSORIES)

Equipment Type	Dimension (Length x Height x Thickness) (mm)	Color	Voltage Rating (V)	Current Rating (A)	Part Number	Quantity (Pieces) per pack
 <p>Resettable Thermal Automotive Circuit Breaker</p>	20.3 x 28 x 6	Green	32VDC	6	10134384-001LF	20
		Yellow	32VDC	8	10134384-002LF	
		Red	32VDC	10	10134384-003LF	
		Blue	32VDC	15	10134384-004LF	
		White	32VDC	25	10134384-005LF	
 <p>Automotive Circuit Breaker with Manual Release Option</p>	20.3 x 29.5 x 6	Green	32VDC	6	10134385-001LF	20
		Yellow	32VDC	8	10134385-002LF	
		Red	32VDC	10	10134385-003LF	
		Blue	32VDC	15	10134385-004LF	
		White	32VDC	25	10134385-005LF	
 <p>Miniaturized Single Pole Thermal Circuit Breaker with Switching Function (Push- push Actuation)</p>	24.4 x 55 x 8.2	Black	250VAC / 72VDC	0.25	10134386-001LF	20
			250VAC / 72VDC	0.5	10134386-002LF	
			250VAC / 72VDC	1	10134386-003LF	
			250VAC / 72VDC	2	10134386-004LF	
			250VAC / 72VDC	3	10134386-005LF	
			250VAC / 72VDC	4	10134386-006LF	
			250VAC / 72VDC	6	10134386-007LF	
			250VAC / 72VDC	8	10134386-008LF	
			250VAC / 72VDC	10	10134386-009LF	

▶ EQUIPMENT(ACCESSORIES)

Equipment Type		Dimension (Length x Height x Thickness) (mm)	Color	Voltage Rating (V)	Current Rating (A)	Part Number	Quantity (Pieces) per pack
	Holder for 5x20mm Glass Fuse	40 x 16 x 6.1	Black	300	10	10134380-001LF	20
	Holder for 6,3x32mm Glass Fuse	50 x 20 x 7.5	Black	300	16	10134381-001LF	20

▶ **POWER TERMINAL BLOCKS**

The power terminal blocks range includes single and multiple solutions.

The compact and robust design makes the power solution flexible and suitable for all customer needs.



TARGET MARKETS

- Control Cabinets for Machinery
- Control Cabinets for Buildings
- Power Distribution Cabinets
- Process Automation

FEATURES

- Compact design
- Large connection space
- Flexible and comprehensive range
- Optimum guidance for the screwdriver
- Good contact stability – permanently
- Vibration resistance clamp
- RoHS compliant, lead-free, halogen-free

BENEFITS

- Space saving
- Enables rigid and flexible conductors
- One solution for all needs
- Easy to install
- Maintenance free
- Guarantees a gas-tight contact point and high contact force
- Meets environmental, health and safety requirements

▶ USUAL TYPE POWER TERMINAL BLOCKS



70mm² - 1000V - 192A

Voltage Rating (V)	Current Rating (A)
1000	192

Part Number

Color	Part Number	Quantity (Pieces) per pack
Beige	10134308-001LF	10

Technical Information

Rated Cross Section (mm ²)	Dimension (Length x Height x Thickness) (mm)	Conducting Bar (mm)	Bolt Thread
70.0	84 x 55 x 41	25 x 3	M8 ch13

Accessories

Description	Part Number	Quantity (Pieces) per pack	Page
Marking Tags for screw terminal blocks (4.8mm x 5mm)	10134314-001LF	100	90
Marking Tags for cover (4.8mm x 11mm)	10134315-001LF	100	90
Marking Tags Adapter for screw terminal blocks	10134316-001LF	100	91
Marking Tags Adapter for cover	10134317-001LF	100	91
End Bracket Width 9 mm	10134389-001LF	50	97
End Bracket Width 6 mm	10134390-001LF		97
End Plate	10134322-001LF	25	95
Cover	10134320-001LF	1	95
Jumper Bar	10134321-001LF	10	99

▶ USUAL TYPE POWER TERMINAL BLOCKS



95mm² - 1000V - 232A

Voltage Rating (V)	Current Rating (A)
1000	232

Part Number

Color	Part Number	Quantity (Pieces) per pack
Beige	10134309-001LF	10

Technical Information

Rated Cross Section (mm ²)	Dimension (Length x Height x Thickness) (mm)	Conducting Bar (mm)	Bolt Thread
95.0	84 x 55 x 41	25 x 4	M8 ch13

Accessories

Description	Part Number	Quantity (Pieces) per pack	Page
Marking Tags for screw terminal blocks (4.8mm x 5mm)	10134314-001LF	100	90
Marking Tags for cover (4.8mm x 11mm)	10134315-001LF	100	90
Marking Tags Adapter for screw terminal blocks	10134316-001LF	100	91
Marking Tags Adapter for cover	10134317-001LF	100	91
End Bracket Width 9 mm	10134389-001LF	50	97
End Bracket Width 6 mm	10134390-001LF		97
End Plate	10134322-001LF	25	95
Cover	10134320-001LF	1	95
Jumper Bar	10134321-001LF	10	99

▶ USUAL TYPE POWER TERMINAL BLOCKS



120mm² - 1000V - 269A

Voltage Rating (V)	Current Rating (A)
1000	269

Part Number

Color	Part Number	Quantity (Pieces) per pack
Beige	10134310-001LF	10

Technical Information

Rated Cross Section (mm ²)	Dimension (Length x Height x Thickness) (mm)	Conducting Bar (mm)	Bolt Thread
120.0	88 x 59 x 41	25 x 6	M10 ch17

Accessories

Description	Part Number	Quantity (Pieces) per pack	Page
Marking Tags for screw terminal blocks (4.8mm x 5mm)	10134314-001LF	100	90
Marking Tags for cover (4.8mm x 11mm)	10134315-001LF	100	90
Marking Tags Adapter for screw terminal blocks	10134316-001LF	100	91
Marking Tags Adapter for cover	10134317-001LF	100	91
End Bracket Width 9 mm	10134389-001LF	50	97
End Bracket Width 6 mm	10134390-001LF		97
End Plate	10134322-001LF	25	95
Cover	10134320-001LF	1	95
Jumper Bar	10134318-001LF	10	99

▶ USUAL TYPE POWER TERMINAL BLOCKS



150mm² - 1000V - 309A

Voltage Rating (V)	Current Rating (A)
1000	309

Part Number

Color	Part Number	Quantity (Pieces) per pack
Beige	10134311-001LF	10

Technical Information

Rated Cross Section (mm ²)	Dimension (Length x Height x Thickness) (mm)	Conducting Bar (mm)	Bolt Thread
150.0	88 x 59 x 41	25 x 6	M10 ch17

Accessories

Description	Part Number	Quantity (Pieces) per pack	Page
Marking Tags for screw terminal blocks (4.8mm x 5mm)	10134314-001LF	100	90
Marking Tags for cover (4.8mm x 11mm)	10134315-001LF	100	90
Marking Tags Adapter for screw terminal blocks	10134316-001LF	100	91
Marking Tags Adapter for cover	10134317-001LF	100	91
End Bracket Width 9 mm	10134389-001LF	50	97
End Bracket Width 6 mm	10134390-001LF		97
End Plate	10134322-001LF	25	95
Cover	10134320-001LF	1	95
Jumper Bar	10134318-001LF	10	99

▶ USUAL TYPE POWER TERMINAL BLOCKS



185mm² - 1000V - 352A

Voltage Rating (V)	Current Rating (A)
1000	352

Part Number

Color	Part Number	Quantity (Pieces) per pack
Beige	10134312-001LF	8

Technical Information

Rated Cross Section (mm ²)	Dimension (Length x Height x Thickness) (mm)	Conducting Bar (mm)	Bolt Thread
185.0	105 x 64 x 41	25 x 8	M12 ch19

Accessories

Description	Part Number	Quantity (Pieces) per pack	Page
Marking Tags for screw terminal blocks(4.8mm x 5mm)	10134314-001LF	100	90
Marking Tags for cover(4.8mm x 11mm)	10134315-001LF	100	90
Marking Tags Adapter for screw terminal blocks	10134316-001LF	100	91
Marking Tags Adapter for cover	10134317-001LF	100	91
End Bracket Width 9 mm	10134389-001LF	50	97
End Bracket Width 6 mm	10134390-001LF		97
End Plate	10134322-001LF	25	95
Cover	10134320-001LF	1	95
Jumper Bar	10134319-001LF	10	99

▶ USUAL TYPE POWER TERMINAL BLOCKS



240mm² - 1000V - 415A

Voltage Rating (V)	Current Rating (A)
1000	415

Part Number

Color	Part Number	Quantity (Pieces) per pack
Beige	10134313-001LF	8

Technical Information

Rated Cross Section (mm ²)	Dimension (Length x Height x Thickness) (mm)	Conducting Bar (mm)	Bolt Thread
240.0	105 x 64 x 41	25 x 10	M12 ch19

Accessories

Description	Part Number	Quantity (Pieces) per pack	Page
Marking Tags for screw terminal blocks (4.8mm x 5mm)	10134314-001LF	100	90
Marking Tags for cover (4.8mm x 11mm)	10134315-001LF	100	90
Marking Tags Adapter for screw terminal blocks	10134316-001LF	100	91
Marking Tags Adapter for cover	10134317-001LF	100	91
End Bracket Width 9 mm	10134389-001LF	50	97
End Bracket Width 6 mm	10134390-001LF		97
End Plate	10134322-001LF	25	95
Cover	10134320-001LF	1	95
Jumper Bar	10134319-001LF	10	99

▶ CLOSED TYPE POWER TERMINAL BLOCKS



50mm² - 1000V - 160A

Voltage Rating (V)	Current Rating (A)
1000	160

Part Number

Color	Part Number	Quantity (Pieces) per pack
Grey	10134323-001LF	50
Blue	10134323-002LF	
Yellow Green	10134323-003LF	

Technical Information

Rated Cross Section (mm ²)	Level	Rigid Conductor (mm ²)	Flexible Conductor (mm ²)	Dimension (Length x Height x Thickness) (mm)	Stripping Length (mm)	Screw-Recessed Allen Screw	Tightening Torque: 1.5-2.5mm ²	Tightening Torque: 4-10mm ²	Tightening Torque: 16-50mm ²
50.0	1	1 x 1.5-50.0	1 x 1.5-50.0	47.6 x 38 x 18	15	M10 - SW5	1.5Nm	5Nm	10Nm

Accessories

Description	Part Number	Quantity (Pieces) per pack	Page
End Bracket Width 9 mm	10134389-001LF	50	97
End Bracket Width 6 mm	10134390-001LF		97

▶ CLOSED TYPE POWER TERMINAL BLOCKS



50mm² - 1000V - 320A

Voltage Rating (V)	Current Rating (A)
1000	320

Part Number

Color	Part Number	Quantity (Pieces) per pack
Grey	10134325-001LF	15
Blue	10134325-002LF	
Yellow Green	10134325-003LF	

Technical Information

Rated Cross Section (mm ²)	Level	Rigid Conductor (mm ²)	Flexible Conductor (mm ²)	Dimension (Length x Height x Thickness) (mm)	Stripping Length (mm)	Screw-Recessed Allen Screw	Tightening Torque: 1.5-2.5mm ²	Tightening Torque: 4-10mm ²	Tightening Torque: 16-50mm ²
50.0	Multiple	2 x 1.5-50.0	2 x 1.5-50.0	47.6 x 38 x 30	15	M10 - SW5	1.5Nm	5Nm	10Nm

Accessories

Description	Part Number	Quantity (Pieces) per pack	Page
End Bracket Width 9 mm	10134389-001LF	50	97
End Bracket Width 6 mm	10134390-001LF		97

▶ CLOSED TYPE POWER TERMINAL BLOCKS



50mm² - 690V - 490A

Voltage Rating (V)	Current Rating (A)
1000	160

Part Number

Color	Part Number	Quantity (Pieces) per pack
Grey	10134324-001LF	20

Technical Information

Rated Cross Section (mm ²)	Level	Rigid Conductor (mm ²)	Flexible Conductor (mm ²)	Dimension (Length x Height x Thickness) (mm)	Stripping Length (mm)	Screw-Recessed Allen Screw	Tightening Torque: 1.5-2.5mm ²	Tightening Torque: 4-10mm ²	Tightening Torque: 16-50mm ²
50.0	Multiple	3 x 1.5-50	3 x 1.5-50	49 x 36 x 49.2	15	M10-SW5	1.5Nm	5Nm	10Nm

Accessories

Description	Part Number	Quantity (Pieces) per pack	Page
End Bracket Width 9 mm	10134389-001LF	50	97
End Bracket Width 6 mm	10134390-001LF		97

▶ CLOSED TYPE POWER TERMINAL BLOCKS



95mm² - 1000V - 245A

Voltage Rating (V)	Current Rating (A)
1000	245

Part Number

Color	Part Number	Quantity (Pieces) per pack
Grey	10134326-001LF	20
Blue	10134326-002LF	
Yellow Green	10134326-003LF	

Technical Information

Rated Cross Section (mm ²)	Level	Rigid Conductor (mm ²)	Flexible Conductor (mm ²)	Dimension (Length x Height x Thickness) (mm)	Stripping Length (mm)	Screw-Recessed Allen Screw	Tightening Torque: 6-25mm ²	Tightening Torque: 35-95mm ²
95.0	1	1 x 6.0-95.0	1 x 6.0-95.0	84 x 51 x 24.8	20	M14-SW6	12Nm	22Nm

Accessories

Description	Part Number	Quantity (Pieces) per pack	Page
End Bracket Width 9 mm	10134389-001LF	50	97
End Bracket Width 6 mm	10134390-001LF		97

▶ CLOSED TYPE POWER TERMINAL BLOCKS



95mm² - 690V - 490A

Voltage Rating (V)	Current Rating (A)
690	490

Part Number

Color	Part Number	Quantity (Pieces) per pack
Grey	10134327-001LF	30
Blue	10134327-002LF	
Yellow Green	10134327-003LF	

Technical Information

Rated Cross Section (mm ²)	Level	Rigid Conductor (mm ²)	Flexible Conductor (mm ²)	Dimension (Length x Height x Thickness) (mm)	Stripping Length (mm)	Screw-Recessed Allen Screw	Tightening Torque: 6-25mm ²	Tightening Torque: 35-95mm ²
95.0	Multiple	2 x 6.0-95.0	2 x 6.0-95.0	84 x 46 x 42	20	M14-SW6	12Nm	22Nm

Accessories

Description	Part Number	Quantity (Pieces) per pack	Page
End Bracket Width 9 mm	10134389-001LF	50	97
End Bracket Width 6 mm	10134390-001LF		97

▶ **CLOSED TYPE POWER TERMINAL BLOCKS**



120mm² - 690V - 280A

Voltage Rating (V)	Current Rating (A)
690	280

Part Number

Color	Part Number	Quantity (Pieces) per pack
Grey	10134328-001LF	30
Blue	10134328-002LF	
Yellow Green	10134328-003LF	

Technical Information

Rated Cross Section (mm ²)	Level	Rigid Conductor (mm ²)	Flexible Conductor (mm ²)	Dimension (Length x Height x Thickness) (mm)	Stripping Length (mm)	Screw - Recessed Allen Screw	Tightening Torque: 16-35mm ²	Tightening Torque: 50-120mm ²
120.0	1	1 x 16.0-120.0	1 x 16.0-120.0	84 x 48.5 x 30	20	M14-SW6	12Nm	25Nm

Accessories

Description	Part Number	Quantity (Pieces) per pack	Page
End Bracket Width 9 mm	10134389-001LF	50	97
End Bracket Width 6 mm	10134390-001LF		97

▶ CLOSED TYPE POWER TERMINAL BLOCKS



120mm² - 690V - 560A

Voltage Rating (V)	Current Rating (A)
690	560

Part Number

Color	Part Number	Quantity (Pieces) per pack
Grey	10134329-001LF	10
Blue	10134329-002LF	
Yellow Green	10134329-003LF	

Technical Information

Rated Cross Section (mm ²)	Level	Rigid Conductor (mm ²)	Flexible Conductor (mm ²)	Dimension (Length x Height x Thickness) (mm)	Stripping Length (mm)	Screw - Recessed Allen Screw	Tightening Torque: 16-35mm ²	Tightening Torque: 50-120mm ²
120.0	Multiple	2 x 16.0-120.0	2 x 16.0-120.0	84 x 48.5 x 51	20	M14-SW6	12Nm	25Nm

Accessories

Description	Part Number	Quantity (Pieces) per pack	Page
End Bracket Width 9 mm	10134389-001LF	50	97
End Bracket Width 6 mm	10134390-001LF		97

▶ CLOSED TYPE POWER TERMINAL BLOCKS



150mm² - 690V - 320A

Voltage Rating (V)	Current Rating (A)
690	320

Part Number

Color	Part Number	Quantity (Pieces) per pack
Grey	10134330-001LF	20
Blue	10134330-002LF	
Yellow Green	10134330-003LF	

Technical Information

Rated Cross Section (mm ²)	Level	Rigid Conductor (mm ²)	Flexible Conductor (mm ²)	Dimension (Length x Height x Thickness) (mm)	Stripping Length (mm)	Screw - Recessed Allen Screw	Tightening Torque: 25-35mm ²	Tightening Torque: 70-120mm ²	Tightening Torque: 150mm ²
150.0	1	1 x 25.0-150.0	1 x 25.0-150.0	84 x 49 x 31	20	M16-SW6	14Nm	25Nm	30Nm

Accessories

Description	Part Number	Quantity (Pieces) per pack	Page
End Bracket Width 9 mm	10134389-001LF	50	97
End Bracket Width 6 mm	10134390-001LF		97

▶ CLOSED TYPE POWER TERMINAL BLOCKS



150mm² - 690V - 640A

Voltage Rating (V)	Current Rating (A)
690	640

Part Number

Color	Part Number	Quantity (Pieces) per pack
Grey	10134331-001LF	10
Blue	10134331-002LF	
Yellow Green	10134331-003LF	

Technical Information

Rated Cross Section (mm ²)	Level	Rigid Conductor (mm ²)	Flexible Conductor (mm ²)	Dimension (Length x Height x Thickness) (mm)	Stripping Length (mm)	Screw-Recessed Allen Screw	Tightening Torque: 25-35mm ²	Tightening Torque: 70-150mm ²
150.0	Multiple	2 x 25.0-150.0	2 x 25.0-150.0	84 x 49 x 51	20	M16-SW6	14Nm	30Nm

Accessories

Description	Part Number	Quantity (Pieces) per pack	Page
End Bracket Width 9 mm	10134389-001LF	50	97
End Bracket Width 6 mm	10134390-001LF		97

▶ CLOSED TYPE POWER TERMINAL BLOCKS



240mm² - 690V - 425A

Voltage Rating (V)	Current Rating (A)
690	425

Part Number

Color	Part Number	Quantity (Pieces) per pack
Grey	10134332-001LF	20
Blue	10134332-002LF	
Yellow Green	10134332-003LF	

Technical Information

Rated Cross Section (mm ²)	Level	Rigid Conductor (mm ²)	Flexible Conductor (mm ²)	Dimension (Length x Height x Thickness) (mm)	Stripping Length (mm)	Screw - Recessed Allen Screw	Tightening Torque: 35-120mm ²	Tightening Torque: 150-240mm ²
240.0	1	1 x 35.0-240.0	1 x 35.0-240.0	106 x 60 x 37	30	M20-SW8	26Nm	40Nm

Accessories

Description	Part Number	Quantity (Pieces) per pack	Page
End Bracket Width 9 mm	10134389-001LF	50	97
End Bracket Width 6 mm	10134390-001LF		97

▶ CLOSED TYPE POWER TERMINAL BLOCKS



240mm² - 690V - 850A

Voltage Rating (V)	Current Rating (A)
690	850

Part Number

Color	Part Number	Quantity (Pieces) per pack
Grey	10134333-001LF	6
Blue	10134333-002LF	
Yellow Green	10134333-003LF	

Technical Information

Rated Cross Section (mm ²)	Level	Rigid Conductor (mm ²)	Flexible Conductor (mm ²)	Dimension (Length x Height x Thickness) (mm)	Stripping Length (mm)	Screw - Recessed Allen Screw	Tightening Torque: 35-120mm ²	Tightening Torque: 150-240mm ²
240.0	Multiple	2 x 35.0-240.0	2 x 35.0-240.0	106 x 60 x 60	30	M20-SW8	26Nm	40Nm

Accessories

Description	Part Number	Quantity (Pieces) per pack	Page
End Bracket Width 9 mm	10134389-001LF	50	97
End Bracket Width 6 mm	10134390-001LF		97

▶ **CLOSED TYPE POWER TERMINAL BLOCKS**



70mm² - 1000V - 160/200A(AI/Cu)

Voltage Rating (V)	Current Rating (A)
1000	200

Part Number

Color	Part Number	Quantity (Pieces) per pack
Grey	10134334-001LF	24

Technical Information

Rated Cross Section (mm ²)	Input Conductor (mm ²)	Output Conductor (mm ²)	Dimension (Length x Height x Thickness) (mm)	Stripping Length In/Out (mm)	Screw - Recessed Allen Screw	Tightening Torque: 2.5-16mm ²	Tightening Torque: 25-35mm ²	Tightening Torque: 50-70mm ²
70.0	1 x 10-70	6 x 2.5-16	75.8 x 40 x 32.4	20/12	M20-SW8	3Nm	6Nm	10Nm

Accessories

Description	Part Number	Quantity (Pieces) per pack	Page
End Bracket Width 9 mm	10134389-001LF	50	97
End Bracket Width 6 mm	10134390-001LF		97

▶ CLOSED TYPE POWER TERMINAL BLOCKS



120mm² - 1000V - 250/280A(Al/Cu)

Voltage Rating (V)	Current Rating (A)
1000	280

Part Number

Color	Part Number	Quantity (Pieces) per pack
Grey	10134335-001LF	12

Technical Information

Rated Cross Section (mm ²)	Input Conductor (mm ²)	Output Conductor (mm ²)	Dimension (Length x Height x Thickness) (mm)	Stripping Length In/Out (mm)	Screw-Recessed Allen Screw	Tightening Torque: 2.5-16mm ²	Tightening Torque: 25-35mm ²	Tightening Torque: 50-70mm ²	Tightening Torque: 95-120mm ²
120.0	1 x 35-120	2 x 6-35 5 x 2.5-16 4 x 2.5-10	97 x 46 x 44.4	26/12	M20-SW8	3Nm	6Nm	10Nm	19Nm

Accessories

Description	Part Number	Quantity (Pieces) per pack	Page
End Bracket Width 9 mm	10134389-001LF	50	97
End Bracket Width 6 mm	10134390-001LF		97

▶ TEST AND MEASUREMENT TERMINAL BLOCKS

Test and measurement products adopt both screw and spring connecting technology, will be suitable for vibration and usual environment, then meet different customers' test requirement for mutual inductor circuit.

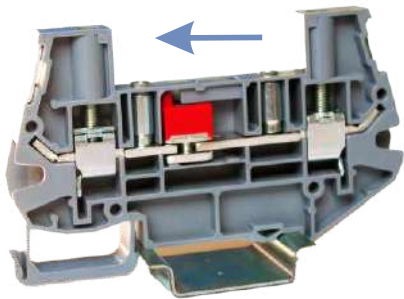

Closed slider

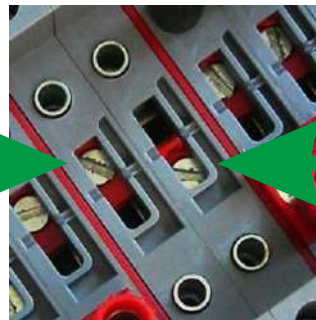

Opened slider

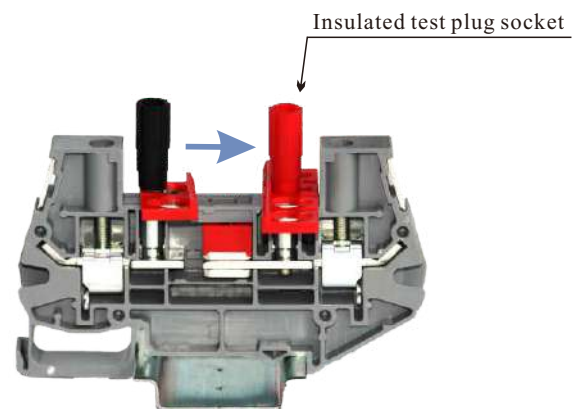

► SCREW TEST AND MEASUREMENT TERMINAL BLOCKS

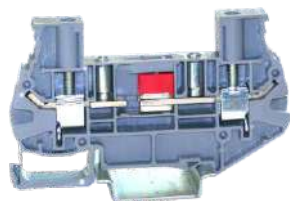

6mm² - 800V - 41A, Disconnect slider

Part Number

Approval

Approval	Voltage Rating (V)	Current Rating (A)
cULus	600	45

Color	Part Number	Quantity (Pieces) per pack
Grey	10134436-001LF	40

Technical Information

Rated Cross Section (mm ²)	Rigid Conductor (mm ²)	Flexible Conductor (mm ²)	Wire Gauge (AWG)	Dimension (Length x Height x Thickness) (mm)	Stripping Length (mm)	Screw	Tightening Torque
6	0.5-6	0.5-6	22-8	84 x 45 x 8	12	M3.5	0.8Nm/ 7 Lb-In

Accessories

Description	Part Number	Quantity (Pieces) per pack	Page
Marking Tags (12mm x 5mm)	10134448-001LF	900	90
Marking Tags (12mm x 6mm)	10134449-001LF	780	90
Marking Tags (12mm x 8mm)	10134450-001LF	675	90
End Bracket width 9mm	10134389-001LF	50	97
End Bracket width 6mm	10134390-001LF		97
Fast-snap End Bracket	10134391-001LF		97
End Plate	10134442-001LF	20	95
Separator	10134443-001LF		95
Insulated Slider Jumper - 2 poles	10134444-001LF		100
Insulated Slider Jumper - 4 poles	10134445-001LF		100
Insulated Test Plug Socket - Red	10134446-001LF		96
Insulated Test Plug Socket - Black	10134447-001LF		96

► SCREW TEST AND MEASUREMENT TERMINAL BLOCKS

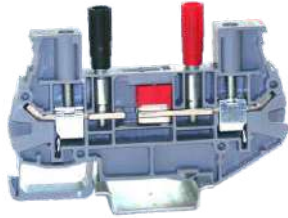

6mm² - 800V - 41A, Amperometric

Part Number

Approval

Approval	Voltage Rating (V)	Current Rating (A)
cULus	600	45

Color	Part Number	Quantity (Pieces) per pack
Grey	10134437-001LF	40

Technical Information

Rated Cross Section (mm ²)	Rigid Conductor (mm ²)	Flexible Conductor (mm ²)	Wire Gauge (AWG)	Dimension (Length x Height x Thickness) (mm)	Stripping Length (mm)	Screw	Tightening Torque
6	0.5-6	0.5-6	22-8	84 x 45 x 8	12	M3.5	0.8Nm/ 7 Lb-In

Accessories

Description	Part Number	Quantity (Pieces) per pack	Page
Marking Tags (12mm x 5mm)	10134448-001LF	900	90
Marking Tags (12mm x 6mm)	10134449-001LF	780	90
Marking Tags (12mm x 8mm)	10134450-001LF	675	90
End Bracket width 9mm	10134389-001LF	50	97
End Bracket width 6mm	10134390-001LF		97
Fast-snap End Bracket	10134391-001LF		97
End Plate	10134442-001LF	20	95
Separator	10134443-001LF		95
Insulated Slider Jumper - 2 poles	10134444-001LF		100
Insulated Slider Jumper - 4 poles	10134445-001LF		100
Insulated Test Plug Socket - Red	10134446-001LF		96
Insulated Test Plug Socket - Black	10134447-001LF		96

► SCREW TEST AND MEASUREMENT TERMINAL BLOCKS

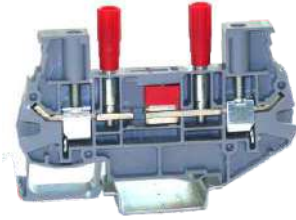

6mm² - 800V - 41A, Voltmetric

Part Number

Approval

Approval	Voltage Rating (V)	Current Rating (A)
cULus	600	45

Color	Part Number	Quantity (Pieces) per pack
Grey	10134438-001LF	40

Technical Information

Rated Cross Section (mm ²)	Rigid Conductor (mm ²)	Flexible Conductor (mm ²)	Wire Gauge (AWG)	Dimension (Length x Height x Thickness) (mm)	Stripping Length (mm)	Screw	Tightening Torque
6	0.5-6	0.5-6	22-8	84 x 45 x 8	12	M3.5	0.8Nm/ 7 Lb-In

Accessories

Description	Part Number	Quantity (Pieces) per pack	Page
Marking Tags (12mm x 5mm)	10134448-001LF	900	90
Marking Tags (12mm x 6mm)	10134449-001LF	780	90
Marking Tags (12mm x 8mm)	10134450-001LF	675	90
End Bracket width 9mm	10134389-001LF	50	97
End Bracket width 6mm	10134390-001LF		97
Fast-snap End Bracket	10134391-001LF		97
End Plate	10134442-001LF	20	95
Separator	10134443-001LF		95
Insulated Slider Jumper - 2 poles	10134444-001LF		100
Insulated Slider Jumper - 4 poles	10134445-001LF		100
Insulated Test Plug Socket - Red	10134446-001LF		96

▶ SPRING CLAMP TEST AND MEASUREMENT TERMINAL BLOCKS

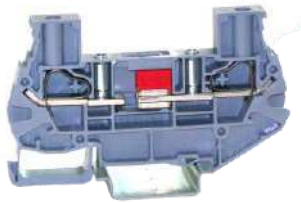

6mm² - 800V - 41A, Disconnect slider

Part Number

Approval

Approval	Voltage Rating (V)	Current Rating (A)
cULus	600	30

Color	Part Number	Quantity (Pieces) per pack
Grey	10134439-001LF	40

Technical Information

Rated Cross Section (mm ²)	Rigid Conductor (mm ²)	Flexible Conductor (mm ²)	Wire Gauge (AWG)	Dimension (Length x Height x Thickness) (mm)	Stripping Length (mm)
6	0.5-6	0.5-6	24-10	84 x 45 x 8	12

Accessories

Description	Part Number	Quantity (Pieces) per pack	Page
Marking Tags (12mm x 5mm)	10134448-001LF	900	90
Marking Tags (12mm x 6mm)	10134449-001LF	780	90
Marking Tags (12mm x 8mm)	10134450-001LF	675	90
End Bracket width 9mm	10134389-001LF	50	97
End Bracket width 6mm	10134390-001LF		97
Fast-snap End Bracket	10134391-001LF		97
End Plate	10134442-001LF	20	95
Separator	10134443-001LF		95
Insulated Slider Jumper - 2 poles	10134444-001LF		100
Insulated Slider Jumper - 4 poles	10134445-001LF		100
Insulated Test Plug Socket - Red	10134446-001LF		96
Insulated Test Plug Socket - Black	10134447-001LF		96

▶ SPRING CLAMP TEST AND MEASUREMENT TERMINAL BLOCKS

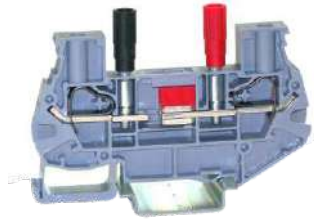

6mm² - 800V - 41A, Amperometric

Part Number

Approval

Approval	Voltage Rating (V)	Current Rating (A)
cULus	600	30

Color	Part Number	Quantity (Pieces) per pack
Grey	10134440-001LF	40

Technical Information

Rated Cross Section (mm ²)	Rigid Conductor (mm ²)	Flexible Conductor (mm ²)	Wire Gauge (AWG)	Dimension (Length x Height x Thickness) (mm)	Stripping Length (mm)
6	0.5-6	0.5-6	24-10	84 x 45 x 8	12

Accessories

Description	Part Number	Quantity (Pieces) per pack	Page
Marking Tags (12mm x 5mm)	10134448-001LF	900	90
Marking Tags (12mm x 6mm)	10134449-001LF	780	90
Marking Tags (12mm x 8mm)	10134450-001LF	675	90
End Bracket width 9mm	10134389-001LF	50	97
End Bracket width 6mm	10134390-001LF		97
Fast-snap End Bracket	10134391-001LF		97
End Plate	10134442-001LF	20	95
Separator	10134443-001LF		95
Insulated Slider Jumper - 2 poles	10134444-001LF		100
Insulated Slider Jumper - 4 poles	10134445-001LF		100
Insulated Test Plug Socket - Red	10134446-001LF		96
Insulated Test Plug Socket - Black	10134447-001LF		96

▶ SPRING CLAMP TEST AND MEASUREMENT TERMINAL BLOCKS

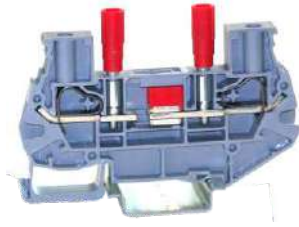

6mm² - 800V - 41A, Voltmetric

Part Number

Approval

Approval	Voltage Rating (V)	Current Rating (A)
cULus	600	30

Color	Part Number	Quantity (Pieces) per pack
Grey	10134441-001LF	40

Technical Information

Rated Cross Section (mm ²)	Rigid Conductor (mm ²)	Flexible Conductor (mm ²)	Wire Gauge (AWG)	Dimension (Length x Height x Thickness) (mm)	Stripping Length (mm)
6	0.5-6	0.5-6	24-10	84 x 45 x 8	12

Accessories

Description	Part Number	Quantity (Pieces) per pack	Page
Marking Tags (12mm x 5mm)	10134448-001LF	900	90
Marking Tags (12mm x 6mm)	10134449-001LF	780	90
Marking Tags (12mm x 8mm)	10134450-001LF	675	90
End Bracket width 9mm	10134389-001LF	50	97
End Bracket width 6mm	10134390-001LF		97
Fast-snap End Bracket	10134391-001LF		97
End Plate	10134442-001LF	20	95
Separator	10134443-001LF		95
Insulated Slider Jumper - 2 poles	10134444-001LF		100
Insulated Slider Jumper - 4 poles	10134445-001LF		100
Insulated Test Plug Socket - Red	10134446-001LF		96

MARKING TAGS

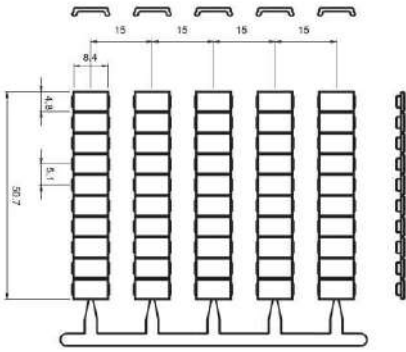

Part Number	Description	Dimension (mm)		Pitch	Color	Quantity (Pieces) per pack
		Length	Height			
10134397-001LF	Blank large marking tags for spring clamp terminals	4.8	8.4	5.1	White	500(10 x 50)

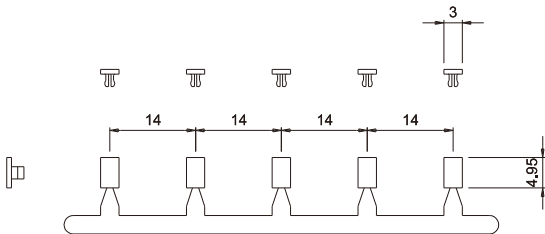

Part Number	Description	Dimension (mm)		Color	Quantity (Pieces) per pack
		Length	Height		
10134398-001LF	Blank single-digit marking tags	5	3	White	100(20 x 5)
10134398-002LF	Printed single-digit marking tags with number: '1'	5	3	White	100(20 x 5)
10134398-003LF	Printed single-digit marking tags with number: '2'	5	3	White	100(20 x 5)
10134398-004LF	Printed single-digit marking tags with number: '3'	5	3	White	100(20 x 5)
10134398-005LF	Printed single-digit marking tags with number: '4'	5	3	White	100(20 x 5)
10134398-006LF	Printed single-digit marking tags with number: '5'	5	3	White	100(20 x 5)
10134398-007LF	Printed single-digit marking tags with number: '6'	5	3	White	100(20 x 5)
10134398-008LF	Printed single-digit marking tags with number: '7'	5	3	White	100(20 x 5)
10134398-009LF	Printed single-digit marking tags with number: '8'	5	3	White	100(20 x 5)
10134398-010LF	Printed single-digit marking tags with number: '9'	5	3	White	100(20 x 5)
10134398-011LF	Printed single-digit marking tags with number: '0'	5	3	White	100(20 x 5)
10134398-012LF	Printed single-digit marking tags with letter: 'A'	5	3	White	100(20 x 5)
10134398-013LF	Printed single-digit marking tags with letter: 'B'	5	3	White	100(20 x 5)
10134398-014LF	Printed single-digit marking tags with letter: 'C'	5	3	White	100(20 x 5)
10134398-015LF	Printed single-digit marking tags with letter: 'D'	5	3	White	100(20 x 5)
10134398-016LF	Printed single-digit marking tags with letter: 'E'	5	3	White	100(20 x 5)

MARKING TAGS

Part Number	Description	Dimension (mm)		Color	Quantity (Pieces) per pack
		Length	Height		
10134398-017LF	Printed single-digit marking tags with letter: 'F'	5	3	White	100(20 x 5)
10134398-018LF	Printed single-digit marking tags with letter: 'G'	5	3	White	100(20 x 5)
10134398-019LF	Printed single-digit marking tags with letter: 'H'	5	3	White	100(20 x 5)
10134398-020LF	Printed single-digit marking tags with letter: 'I'	5	3	White	100(20 x 5)
10134398-021LF	Printed single-digit marking tags with letter: 'J'	5	3	White	100(20 x 5)
10134398-022LF	Printed single-digit marking tags with letter: 'K'	5	3	White	100(20 x 5)
10134398-023LF	Printed single-digit marking tags with letter: 'L'	5	3	White	100(20 x 5)
10134398-024LF	Printed single-digit marking tags with letter: 'M'	5	3	White	100(20 x 5)
10134398-025LF	Printed single-digit marking tags with letter: 'N'	5	3	White	100(20 x 5)
10134398-026LF	Printed single-digit marking tags with letter: 'P'	5	3	White	100(20 x 5)
10134398-027LF	Printed single-digit marking tags with letter: 'Q'	5	3	White	100(20 x 5)
10134398-028LF	Printed single-digit marking tags with letter: 'R'	5	3	White	100(20 x 5)
10134398-029LF	Printed single-digit marking tags with letter: 'S'	5	3	White	100(20 x 5)
10134398-030LF	Printed single-digit marking tags with letter: 'T'	5	3	White	100(20 x 5)
10134398-031LF	Printed single-digit marking tags with letter: 'U'	5	3	White	100(20 x 5)
10134398-032LF	Printed single-digit marking tags with letter: 'V'	5	3	White	100(20 x 5)
10134398-033LF	Printed single-digit marking tags with letter: 'W'	5	3	White	100(20 x 5)
10134398-034LF	Printed single-digit marking tags with letter: 'X'	5	3	White	100(20 x 5)
10134398-035LF	Printed single-digit marking tags with letter: 'Y'	5	3	White	100(20 x 5)
10134398-036LF	Printed single-digit marking tags with letter: 'Z'	5	3	White	100(20 x 5)
10134398-037LF	Printed single-digit marking tags with symbol: 'P'	5	3	White	100(20 x 5)
10134398-038LF	Printed single-digit marking tags with symbol: '='	5	3	White	100(20 x 5)
10134398-039LF	Printed single-digit marking tags with symbol: '['	5	3	White	100(20 x 5)
10134398-040LF	Printed single-digit marking tags with symbol: ']'	5	3	White	100(20 x 5)
10134398-041LF	Printed single-digit marking tags with symbol: '+'	5	3	White	100(20 x 5)

MARKING TAGS

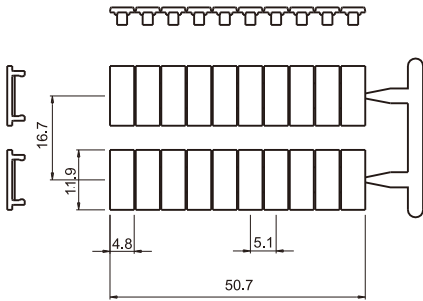

Part Number	Description	Dimension (mm)		Pitch	Color	Quantity (Pieces) per pack
		Length	Height			
10134400-001LF	Blank large marking tags for screw terminals	5	12	5.1	White	500(25 x 20)

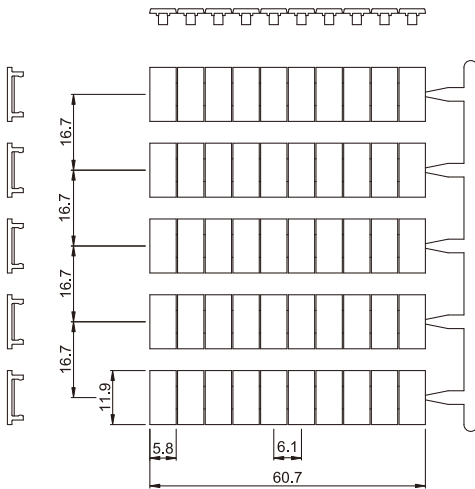

Part Number	Description	Dimension (mm)		Pitch	Color	Quantity (Pieces) per pack
		Length	Height			
10134401-001LF	Blank large marking tags for screw terminals	6	12	6.1	White	500(10 x 50)

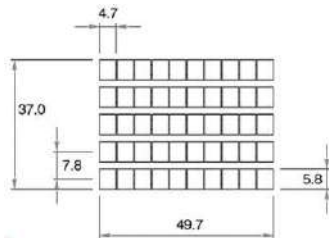

Part Number	Description	Dimension (mm)		Pitch	Color	Quantity (Pieces) per pack
		Length	Height			
10134402-001LF	Blank large marking tags for screw terminals	5	5.8	5.1	White	500(10 x 50)

MARKING TAGS

Part Number	Description	Dimension (mm)		Pitch	Color	Quantity (Pieces) per pack
		Length	Height			
10134419-001LF	Vertical marking tags - 10 poles	4.5	12	5.1	White	500(50 x 10)



Part Number	Description	Dimension (mm)		Pitch	Color	Quantity (Pieces) per pack
		Length	Height			
10134314-001LF	Blank large marking tags for screw terminal blocks	4.8	5	5	White	100(2 x 50)



Part Number	Description	Dimension (mm)		Pitch	Color	Quantity (Pieces) per pack
		Length	Height			
10134315-001LF	Blank large marking tags for cover screw terminal blocks	4.8	11	5	White	100(2 x 50)



Part Number	Description	Dimension (mm)		Pitch	Color	Quantity (Pieces) per pack
		Length	Height			
10134448-001LF	Marking tags	12	5	5	White	900(20 x 45)



Part Number	Description	Dimension (mm)		Pitch	Color	Quantity (Pieces) per pack
		Length	Height			
10134449-001LF	Marking tags	12	6	6	White	780(20 x 39)



Part Number	Description	Dimension (mm)		Pitch	Color	Quantity (Pieces) per pack
		Length	Height			
10134450-001LF	Marking tags	12	8	8	White	675(25 x 27)



▶ MARKING TAGS ADAPTER

Part Number	Description	Dimension (mm)		Color	Quantity (Pieces) per pack
		Length	Height		
10134316-001LF	Marking tags adapter for screw terminal blocks	27	13	Beige	100



Part Number	Description	Dimension (mm)		Color	Quantity (Pieces) per pack
		Length	Height		
10134317-001LF	Marking tags adapter for cover screw terminal blocks	13.3	16	Beige	100

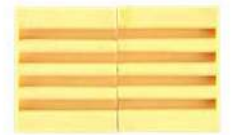

Part Number	Description	Dimension (mm)			Color	Quantity (Pieces) per pack
		Length	Height	Thickness		
10134399-001LF	Marking tag adapter	20.5	3.0	5.9	Grey	50

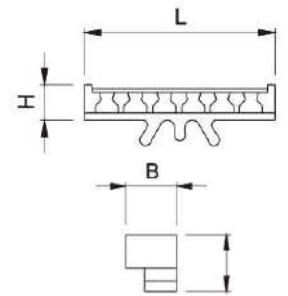

▶ END PLATES FOR SCREW TERMINAL BLOCKS

Part Number	Suitable For	Dimension (mm)			Color	Quantity (Pieces) per pack
		Length	Height	Thickness		
10134259-001LF	Screw Terminal Blocks - 2.5 to 4.0mm ²	44	35	1.5	Grey	100
10134260-001LF	Screw Terminal Blocks - 6.0 to 10.0mm ²	50	43	1.5	Grey	
10134261-001LF	Screw Terminal Blocks - 16.0 to 25.0mm ²	56	48	1.5	Grey	50
10134262-001LF	Screw Terminal Blocks - 35.0 to 50.0mm ²	62	60	1.5	Grey	



▶ END PLATES FOR MULTI-STAGE SCREW TERMINAL BLOCKS

Part Number	Suitable For	Dimension (mm)			Color	Quantity (Pieces) per pack
		Length	Height	Thickness		
10134292-001LF	Two Stage Screw Terminal Blocks - 2.5 to 4.0mm ²	72.5	49	1.5	Grey	50



Part Number	Suitable For	Dimension (mm)			Color	Quantity (Pieces) per pack
		Length	Height	Thickness		
10134297-001LF	Three Stage Screw Terminal Blocks - 2.5mm ²	75.4	50	1.5	Grey	25



Part Number	Suitable For	Dimension (mm)			Color	Quantity (Pieces) per pack
		Length	Height	Thickness		
10134298-001LF	Three Stage Screw Terminal Blocks - 2.5mm ²	55.4	50	1.5	Grey	25



▶ SEPARATOR FOR SCREW TERMINAL BLOCKS

Part Number	Suitable For	Dimension (mm)			Color	Quantity (Pieces) per pack
		Length	Height	Thickness		
10134263-001LF	Screw Terminal Blocks - 2.5 to 4.0mm ²	55	44	1.5	Grey	100
10134264-001LF	Screw Terminal Blocks - 6.0 to 10.0mm ²	55	49	1.5	Grey	



▶ **END PLATES FOR SPRING TERMINAL BLOCKS**

Part Number	Suitable For	Dimension (mm)			Color	Quantity (Pieces) per pack
		Length	Height	Thickness		
10134342-001LF	Spring Clamp Terminal Blocks - 2.5mm ²	50	28	1.5	Grey	50
10134343-001LF	Spring Clamp Terminal Blocks - 4.0mm ²	57.4	33.6	1.5	Grey	
10134344-001LF	Spring Clamp Terminal Blocks - 6.0mm ²	63	38	1.5	Grey	



Part Number	Suitable For	Dimension (mm)			Color	Quantity (Pieces) per pack
		Length	Height	Thickness		
10134345-001LF	Spring Clamp Terminal Blocks - 2.5mm ²	98	37	1.5	Grey	25



Part Number	Suitable For	Dimension (mm)			Color	Quantity (Pieces) per pack
		Length	Height	Thickness		
10134346-001LF	Spring Clamp Terminal Blocks - 2.5 to 4.0mm ²	87	28	1.5	Grey	25



Part Number	Suitable For	Dimension (mm)			Color	Quantity (Pieces) per pack
		Length	Height	Thickness		
10134347-001LF	Spring Clamp Terminal Blocks - 2.5 to 3.0mm ²	68.6	28	1.5	Grey	25



▶ END PLATES FOR PLUGGABLE TERMINAL BLOCKS

Part Number	Suitable For	Dimension (mm)			Color	Quantity (Pieces) per pack
		Length	Height	Thickness		
10134360-001LF	Pluggable Terminal Blocks - without holes	57.5	28.5	1.6	Grey	25
10134360-002LF	Pluggable Terminal Blocks - with holes	57.5	28.5	1.6	Grey	



Part Number	Suitable For	Dimension (mm)			Color	Quantity (Pieces) per pack
		Length	Height	Thickness		
10134361-001LF	Two Stage Pluggable Terminal Blocks - without holes	75.6	51	1.6	Grey	25
10134361-002LF	Two Stage Pluggable Terminal Blocks - with holes	75.6	51	1.6	Grey	



Part Number	Suitable For	Dimension (mm)			Color	Quantity (Pieces) per pack
		Length	Height	Thickness		
10134362-001LF	Pluggable Terminal Blocks - without holes	63.9	28.5	1.6	Grey	25
10134362-002LF	Pluggable Terminal Blocks - with holes	63.9	28.5	1.6	Grey	



▶ SPACER FOR PLUGGABLE TERMINAL BLOCKS

Part Number	Suitable For	Dimension (mm)			Color	Quantity (Pieces) per pack
		Length	Height	Thickness		
10134363-001LF	Pluggable Terminal Blocks	57.5	28.5	2.5	Grey	25



Part Number	Suitable For	Dimension (mm)			Color	Quantity (Pieces) per pack
		Length	Height	Thickness		
10134364-001LF	Two Stage Pluggable Terminal Blocks	75.6	51	2.5	Grey	25



Part Number	Suitable For	Dimension (mm)			Color	Quantity (Pieces) per pack
		Length	Height	Thickness		
10134421-001LF	Pluggable Terminal Blocks	63.9	28.5	2.5	Grey	25

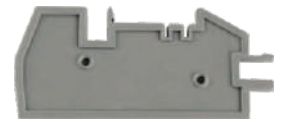

▶ END PLATE & SEPARATOR FOR UNIVERSAL TERMINAL BLOCKS

Part Number	Suitable For	Dimension (mm)			Color	Quantity (Pieces) per pack
		Length	Height	Thickness		
10134378-001LF	Universal Terminal Blocks - End Plate	55	33	1	Grey	50
10134378-002LF	Universal Terminal Blocks - Separator	55	33	1.5	Grey	



▶ END PLATE FOR POWER TERMINAL BLOCKS

Part Number	Description	Dimension (mm)			Color	Quantity (Pieces) per pack
		Length	Height	Thickness		
10134322-001LF	End Plate for power terminal blocks	153	70	6	Beige	25



▶ END PLATE FOR TEST AND MEASUREMENT TERMINAL BLOCKS

Part Number	Description	Dimension (mm)			Color	Quantity (Pieces) per pack
		Length	Height	Thickness		
10134442-001LF	End Plate for test and measurement terminal blocks	83.8	48.3	1	Grey	20



▶ SEPARATOR FOR TEST AND MEASUREMENT TERMINAL BLOCKS

Part Number	Description	Dimension (mm)			Color	Quantity (Pieces) per pack
		Length	Height	Thickness		
10134443-001LF	Separator for test and measurement terminal blocks	94	48.3	1	Red	20



▶ COVER FOR POWER TERMINAL BLOCKS

Part Number	Description	Dimension (mm)			Color	Quantity (Pieces) per pack
		Length	Height	Thickness		
10134320-001LF	Cover for power terminal blocks	200	75	42	Yellow	1



▶ TEST PLUG ADAPTER

Part Number	Description	Plug Diameter (mm)	Quantity (Pieces) per pack
10134276-001LF	Red Test Plug Adapter	2.8	10

Part Number	Description	Plug Diameter (mm)	Quantity (Pieces) per pack
10134276-002LF	Black Test Plug Adapter	2.8	10



▶ TEST PLUG SOCKET

Part Number	Description	Dimension (mm)			Quantity (Pieces) per pack
		Length	Diameter	Thread	
10134446-001LF	Red Insulated Test Plug Socket - 2 poles	36	6.9	M3	20

Part Number	Description	Dimension (mm)			Quantity (Pieces) per pack
		Length	Diameter	Thread	
10134447-001LF	Black Insulated Test Plug Socket - 4 poles	36	6.9	M3	20



DIN RAIL

Part Number	Description	Dimension (mm)			Quantity (Pieces) per pack
		Length	Height	Thickness	
10134392-001LF	Steel Omega Rail 35 x 7.5mm- 2metres	2000	7.5	35	20 bars of 2m each

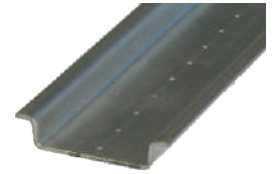

Part Number	Description	Dimension (mm)			Quantity (Pieces) per pack
		Length	Height	Thickness	
10134393-001LF	Slotted Steel Omega Rail 35 x 7.5mm- 2metres	2000	7.5	35	20 bars of 2m each



Part Number	Description	Dimension (mm)			Quantity (Pieces) per pack
		Length	Height	Thickness	
10134394-001LF	Steel Omega Rail 35 x 15mm- 2metres	2000	15	35	10 bars of 2m each

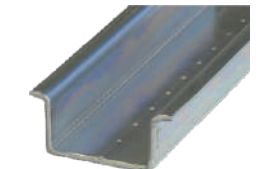

Part Number	Description	Dimension (mm)			Quantity (Pieces) per pack
		Length	Height	Thickness	
10134395-001LF	Slotted Steel Omega Rail 35 x 15mm- 2metres	2000	15	35	10 bars of 2m each

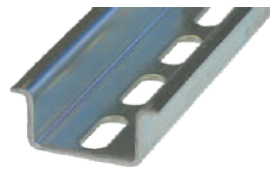

END BRACKETS FOR DIN RAIL

Part Number	Description	Dimension (mm)			Color	Quantity (Pieces) per pack
		Length	Height	Thickness		
10134387-001LF	Angled Support Bracket	80	49	20	Silver	50



Part Number	Description	Dimension (mm)			Color	Quantity (Pieces) per pack
		Length	Height	Thickness		
10134389-001LF	End Bracket for DIN Rail – Width 9mm	58	36	9	Grey	50



Part Number	Description	Dimension (mm)			Color	Quantity (Pieces) per pack
		Length	Height	Thickness		
10134390-001LF	End Bracket for DIN Rail – Width 6mm	55	34	6	Black	50



Part Number	Description	Dimension (mm)			Color	Quantity (Pieces) per pack
		Length	Height	Thickness		
10134391-001LF	Fast Snap End Bracket for DIN Rail	55	34	6	Black	50



JUMPERS AND TOOLS

Part Number	Description	Technical Information			Quantity (Pieces) per pack
		Rated Cross Section (mm ²)	Rating Voltage (V)	Current Rating (A)	
10134265-001LF	Screw Jumper bar 9.1mm pitch - 55 poles	10	600	65	1
10134265-002LF	Screw Jumper bar 9.1mm pitch - 2 poles	10	600	65	100
10134265-003LF	Screw Jumper bar 9.1mm pitch - 3 poles	10	600	65	100
10134265-004LF	Screw Jumper bar 9.1mm pitch - 4 poles	10	600	65	100



Part Number	Description	Technical Information			Quantity (Pieces) per pack
		Rated Cross Section (mm ²)	Rating Voltage (V)	Current Rating (A)	
10134266-001LF	Screw Jumper bar 12.0mm pitch - 41 poles	25	600	85	1
10134266-002LF	Screw Jumper bar 12.0mm pitch - 2 poles	25	600	85	50
10134266-003LF	Screw Jumper bar 12.0mm pitch - 3 poles	25	600	85	50
10134266-004LF	Screw Jumper bar 12.0mm pitch - 4 poles	25	600	85	50



Part Number	Description	Technical Information			Quantity (Pieces) per pack
		Rated Cross Section (mm ²)	Rating Voltage (V)	Current Rating (A)	
10134267-001LF	Screw Jumper bar 16.1mm pitch - 32 poles	50	600	135	1
10134267-002LF	Screw Jumper bar 16.1mm pitch - 2 poles	50	600	135	50
10134267-003LF	Screw Jumper bar 16.1mm pitch - 3 poles	50	600	135	50
10134267-004LF	Screw Jumper bar 16.1mm pitch - 4 poles	50	600	135	25



▶ JUMPERS AND TOOLS

Part Number	Description	Technical Information			Quantity (Pieces) per pack
		Rated Cross Section (mm ²)	Rating Voltage (V)	Current Rating (A)	
10134275-001LF	Insulated Screw Jumper 7.1mm pitch - 2 poles	6	600	50	50
10134275-002LF	Insulated Screw Jumper 7.1mm pitch - 3 poles	6	600	50	50
10134275-003LF	Insulated Screw Jumper 7.1mm pitch - 24 poles	6	600	50	5



Part Number	Description	Dimension (mm)			Color	Quantity (Pieces) per pack
		Length	Height	Thickness		
10134318-001LF	Jumper bar for screw terminal blocks 120-150mm ²	66	4	20	Silver	10
10134319-001LF	Jumper bar for screw terminal blocks 185-240mm ²	66	6	20	Silver	10
10134321-001LF	Jumper Bar for screw terminal blocks 70-95mm ²	66	4	20	Silver	10



Part Number	Description	Technical Information			Crimping Tool	Quantity (Pieces) per pack
		Rated Cross Section (mm ²)	Rating Voltage (V)	Current Rating (A)		
10134272-001LF	Jumper Bar 6.1mm pitch - 2 Poles	4	600	25	10134271-002LF	100
10134272-002LF	Jumper Bar 6.1mm pitch - 3 Poles	4	600	25		
10134272-003LF	Jumper Bar 6.1mm pitch - 24 Poles	4	600	25		5

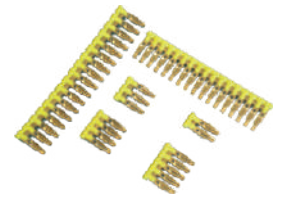

Part Number	Description	Technical Information			Crimping Tool	Quantity (Pieces) per pack
		Rated Cross Section (mm ²)	Rating Voltage (V)	Current Rating (A)		
10134273-001LF	Jumper Bar 5.1mm pitch - 2 Poles	2.5	600	25	10134271-001LF	100
10134273-002LF	Jumper Bar 5.1mm pitch - 3 Poles	2.5	600	25		
10134273-003LF	Jumper Bar 5.1mm pitch - 24 Poles	2.5	600	25		5

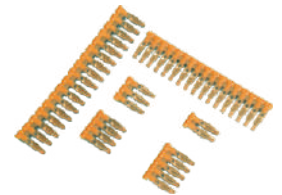

JUMPERS AND TOOLS

Part Number	Description	Technical Information			Crimping Tool	Quantity (Pieces) per pack
		Rated Cross Section (mm ²)	Rating Voltage (V)	Current Rating (A)		
10134274-001LF	Jumper Bar 8.1mm pitch - 2 Poles	6	600	30	10134271-004LF	100
10134274-002LF	Jumper Bar 8.1mm pitch - 3 Poles	6	600	30		10
10134274-003LF	Jumper Bar 8.1mm pitch - 12 Poles	6	600	30		



Part Number	Description	Technical Information			Crimping Tool	Quantity (Pieces) per pack
		Rated Cross Section (mm ²)	Rating Voltage (V)	Current Rating (A)		
10134414-001LF	Jumper Bar 5.1mm pitch - 2 Poles	2.5	300	20	10134271-005LF Blue	100
10134414-002LF	Jumper Bar 5.1mm pitch - 3 Poles	2.5	300	20		10
10134414-003LF	Jumper Bar 5.1mm pitch - 12 Poles	2.5	300	20		
10134414-004LF	Jumper Bar 5.1mm pitch - 2 Poles	2.5	300	20	10134271-005LF Red	100
10134414-005LF	Jumper Bar 5.1mm pitch - 3 Poles	2.5	300	20		10
10134414-006LF	Jumper Bar 5.1mm pitch - 12 Poles	2.5	300	20		



Part Number	Description	Technical Information			Crimping Tool	Quantity (Pieces) per pack
		Rated Cross Section (mm ²)	Rating Voltage (V)	Current Rating (A)		
10134420-001LF	Jumper Bar 9.1mm pitch - 12 Poles	4	300	25	10134271-003LF	10

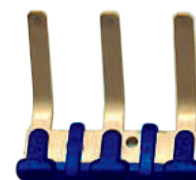

Part Number	Description	Technical Information			Quantity (Pieces) per pack
		Rated Cross Section (mm ²)	Rating Voltage (V)	Current Rating (A)	
10134444-001LF	Insulated Slider Jumper 8.0mm pitch - 2 Poles	6	800	45	20
10134445-001LF	Insulated Slider Jumper 8.0mm pitch - 4 Poles	6	800	45	20



JUMPERS AND TOOLS

Part Number	Description	Specification		Quantity (Pieces) per pack
		Pitch (mm)	Color	
10134271-001LF	Ratchet Cutting Tool for jumper bar 2.5mm ²	5.1	Orange	1



Part Number	Description	Specification		Quantity (Pieces) per pack
		Pitch (mm)	Color	
10134271-002LF	Ratchet Cutting Tool for jumper bar 4mm ²	6.1	Yellow	1



Part Number	Description	Specification		Quantity (Pieces) per pack
		Pitch (mm)	Color	
10134271-003LF	Ratchet Cutting Tool for jumper bar 2.5mm ²	9.1	Blue	1



Part Number	Description	Specification		Quantity (Pieces) per pack
		Pitch (mm)	Color	
10134271-004LF	Ratchet Cutting Tool for jumper bar 6mm ²	8.1	Green	1



Part Number	Description	Specification		Quantity (Pieces) per pack
		Pitch (mm)	Color	
10134271-005LF	Ratchet Cutting Tool for jumper bar 2.5mm ²	5.1	Blue/Red	1



Part Number	Description	Color	Quantity (Pieces) per pack	Page
10134250-001LF	Screw Terminal Blocks Conductor Range – 2.5mm ²	Grey	100	6
10134250-002LF	Screw Terminal Blocks Conductor Range – 2.5mm ²	Black		6
10134250-003LF	Screw Terminal Blocks Conductor Range – 2.5mm ²	Blue		6
10134250-004LF	Screw Terminal Blocks Conductor Range – 2.5mm ²	Brown		6
10134250-005LF	Screw Terminal Blocks Conductor Range – 2.5mm ²	Yellow Green		6
10134250-006LF	Screw Terminal Blocks Conductor Range – 2.5mm ²	Green		6
10134250-007LF	Screw Terminal Blocks Conductor Range – 2.5mm ²	Yellow		6
10134250-008LF	Screw Terminal Blocks Conductor Range – 2.5mm ²	Orange		6
10134250-009LF	Screw Terminal Blocks Conductor Range – 2.5mm ²	Red		6
10134250-010LF	Screw Terminal Blocks Conductor Range – 2.5mm ²	White		6
10134251-001LF	Screw Terminal Blocks Conductor Range – 4.0mm ²	Grey	100	7
10134251-002LF	Screw Terminal Blocks Conductor Range – 4.0mm ²	Black		7
10134251-003LF	Screw Terminal Blocks Conductor Range – 4.0mm ²	Blue		7
10134251-004LF	Screw Terminal Blocks Conductor Range – 4.0mm ²	Brown		7
10134251-005LF	Screw Terminal Blocks Conductor Range – 4.0mm ²	Yellow Green		7
10134251-006LF	Screw Terminal Blocks Conductor Range – 4.0mm ²	Green		7
10134251-007LF	Screw Terminal Blocks Conductor Range – 4.0mm ²	Yellow		7
10134251-008LF	Screw Terminal Blocks Conductor Range – 4.0mm ²	Orange		7
10134251-009LF	Screw Terminal Blocks Conductor Range – 4.0mm ²	Red		7
10134251-010LF	Screw Terminal Blocks Conductor Range – 4.0mm ²	White		7
10134253-001LF	Screw Terminal Blocks Conductor Range – 6.0mm ²	Grey	50	8
10134253-002LF	Screw Terminal Blocks Conductor Range – 6.0mm ²	Black		8
10134253-003LF	Screw Terminal Blocks Conductor Range – 6.0mm ²	Blue		8
10134253-004LF	Screw Terminal Blocks Conductor Range – 6.0mm ²	Brown		8
10134253-005LF	Screw Terminal Blocks Conductor Range – 6.0mm ²	Yellow Green		8
10134253-006LF	Screw Terminal Blocks Conductor Range – 6.0mm ²	Green		8
10134253-007LF	Screw Terminal Blocks Conductor Range – 6.0mm ²	Yellow		8
10134253-008LF	Screw Terminal Blocks Conductor Range – 6.0mm ²	Orange		8
10134253-009LF	Screw Terminal Blocks Conductor Range – 6.0mm ²	Red		8
10134253-010LF	Screw Terminal Blocks Conductor Range – 6.0mm ²	White		8
10134254-001LF	Screw Terminal Blocks Conductor Range – 10.0mm ²	Grey	50	9
10134254-002LF	Screw Terminal Blocks Conductor Range – 10.0mm ²	Blue		9
10134254-003LF	Screw Terminal Blocks Conductor Range – 10.0mm ²	Yellow Green		9
10134254-004LF	Screw Terminal Blocks Conductor Range – 10.0mm ²	Yellow		9
10134254-005LF	Screw Terminal Blocks Conductor Range – 10.0mm ²	Orange		9
10134254-006LF	Screw Terminal Blocks Conductor Range – 10.0mm ²	Red		9
10134255-001LF	Screw Terminal Blocks Conductor Range – 25.0mm ²	Grey	25	10
10134255-002LF	Screw Terminal Blocks Conductor Range – 25.0mm ²	Blue		10
10134255-003LF	Screw Terminal Blocks Conductor Range – 25.0mm ²	Yellow Green		10
10134255-004LF	Screw Terminal Blocks Conductor Range – 25.0mm ²	Yellow		10

Part Number	Description	Color	Quantity (Pieces) per pack	Page
10134256-001LF	Screw Terminal Blocks Conductor Range – 50.0mm ²	Grey	25	11
10134256-002LF	Screw Terminal Blocks Conductor Range – 50.0mm ²	Blue		11
10134256-003LF	Screw Terminal Blocks Conductor Range – 50.0mm ²	Yellow Green		11
10134256-004LF	Screw Terminal Blocks Conductor Range – 50.0mm ²	Yellow		11
10134256-005LF	Screw Terminal Blocks Conductor Range – 50.0mm ²	Red		11
10134257-001LF	Screw Terminal Blocks Conductor Range – 70.0mm ²	Grey	10	12
10134257-002LF	Screw Terminal Blocks Conductor Range – 70.0mm ²	Blue		12
10134257-003LF	Screw Terminal Blocks Conductor Range – 70.0mm ²	Yellow Green		12
10134257-004LF	Screw Terminal Blocks Conductor Range – 70.0mm ²	Yellow		12
10134258-001LF	Screw Terminal Blocks Conductor Range – 95.0mm ²	Grey	10	13
10134258-002LF	Screw Terminal Blocks Conductor Range – 95.0mm ²	Blue		13
10134258-003LF	Screw Terminal Blocks Conductor Range – 95.0mm ²	Yellow Green		13
10134258-004LF	Screw Terminal Blocks Conductor Range – 95.0mm ²	Yellow		13
10134259-001LF	Accessories – End Plate for Screw Terminal Blocks - 2.5 to 4.0mm ²	Grey	100	92
10134260-001LF	Accessories – End Plate for Screw Terminal Blocks - 6.0 to 10.0mm ²	Grey		92
10134261-001LF	Accessories – End Plate for Screw Terminal Blocks - 16.0 to 25.0mm ²	Grey	50	92
10134262-001LF	Accessories – End Plate for Screw Terminal Blocks - 35.0 to 50.0mm ²	Grey		92
10134263-001LF	Accessories – Separator for Screw Terminal Blocks - 2.5 to 4.0mm ²	Grey	100	92
10134264-001LF	Accessories – Separator for Screw Terminal Blocks - 6.0 to 10.0mm ²	Grey	100	92
10134265-001LF	Accessories – Screw Jumper bar 9.1mm pitch - 55 poles	/	1	98
10134265-002LF	Accessories – Screw Jumper bar 9.1mm pitch - 2 poles	/	100	98
10134265-003LF	Accessories – Screw Jumper bar 9.1mm pitch - 3 poles	/	100	98
10134265-004LF	Accessories – Screw Jumper bar 9.1mm pitch - 4 poles	/	100	98
10134266-001LF	Accessories – Screw Jumper bar 12.0mm pitch - 41 poles	/	1	98
10134266-002LF	Accessories – Screw Jumper bar 12.0mm pitch - 2 poles	/	50	98
10134266-003LF	Accessories – Screw Jumper bar 12.0mm pitch - 3 poles	/	50	98
10134266-004LF	Accessories – Screw Jumper bar 12.0mm pitch - 4 poles	/	50	98
10134267-001LF	Accessories – Screw Jumper bar 16.1mm pitch - 32 poles	/	1	98
10134267-002LF	Accessories – Screw Jumper bar 16.1mm pitch - 2 poles	/	50	98
10134267-003LF	Accessories – Screw Jumper bar 16.1mm pitch - 3 poles	/	50	98
10134267-004LF	Accessories – Screw Jumper bar 16.1mm pitch - 4 poles	/	25	98
10134271-001LF	Accessories – Ratchet Cutting Tool for jumper bar 2.5mm ²	Orange	1	101
10134271-002LF	Accessories – Ratchet Cutting Tool for jumper bar 4mm ²	Yellow	1	101
10134271-003LF	Accessories – Ratchet Cutting Tool for jumper bar 2.5mm ²	Blue	1	101
10134271-004LF	Accessories – Ratchet Cutting Tool for jumper bar 6mm ²	Green	1	101
10134271-005LF	Accessories – Ratchet Cutting Tool for jumper bar 2.5mm ²	Blue/Red	1	101
10134272-001LF	Accessories – Jumper Bar 6.1mm pitch – 2 Poles	Yellow	100	99
10134272-002LF	Accessories – Jumper Bar 6.1mm pitch – 3 Poles	Yellow		99
10134272-003LF	Accessories – Jumper Bar 6.1mm pitch – 24 Poles	Yellow	5	99
10134273-001LF	Accessories – Jumper Bar 5.1mm pitch – 2 Poles	Orange	100	99
10134273-002LF	Accessories – Jumper Bar 5.1mm pitch – 3 Poles	Orange		99
10134273-003LF	Accessories – Jumper Bar 5.1mm pitch – 24 Poles	Orange		5

Part Number	Description	Color	Quantity (Pieces) per pack	Page
10134274-001LF	Accessories – Jumper Bar 8.1mm pitch – 2 Poles	Green	100	100
10134274-002LF	Accessories – Jumper Bar 8.1mm pitch – 3 Poles	Green		100
10134274-003LF	Accessories – Jumper Bar 8.1mm pitch – 12 Poles	Green	10	100
10134275-001LF	Accessories – Insulated Screw Jumper 7.1mm pitch - 2 poles	Green	50	99
10134275-002LF	Accessories – Insulated Screw Jumper 7.1mm pitch - 3 poles	Green		99
10134275-003LF	Accessories – Insulated Screw Jumper 7.1mm pitch - 24 poles	Green	5	99
10134276-001LF	Accessories – Red Test Plug Adapter	Red	10	96
10134276-002LF	Accessories – Black Test Plug Adapter	Black		96
10134279-001LF	Screw Ground Terminal Blocks Conductor Range – 4.0mm ²	Yellow Green	50	14
10134280-001LF	Screw Ground Terminal Blocks Conductor Range – 6.0mm ²	Yellow Green	50	15
10134281-001LF	Screw Ground Terminal Blocks Conductor Range – 10.0mm ²	Yellow Green	50	16
10134283-001LF	Screw Ground Terminal Blocks Conductor Range – 25.0mm ²	Yellow Green	25	17
10134284-001LF	Screw Ground Terminal Blocks Conductor Range – 35.0mm ²	Yellow Green	25	18
10134285-001LF	Screw Ground Terminal Blocks Conductor Range – 50.0mm ²	Yellow Green	25	19
10134288-001LF	Screw Multilevel Terminal Blocks Conductor Range – 4.0mm ² , Standard Connection	Grey	50	20
10134288-002LF	Screw Multilevel Terminal Blocks Conductor Range – 4.0mm ² , Standard Connection	Black		20
10134288-003LF	Screw Multilevel Terminal Blocks Conductor Range – 4.0mm ² , Standard Connection	Blue		20
10134288-004LF	Screw Multilevel Terminal Blocks Conductor Range – 4.0mm ² , Standard Connection	Brown		20
10134288-005LF	Screw Multilevel Terminal Blocks Conductor Range – 4.0mm ² , Standard Connection	Yellow Green		20
10134288-006LF	Screw Multilevel Terminal Blocks Conductor Range – 4.0mm ² , Standard Connection	Green		20
10134288-007LF	Screw Multilevel Terminal Blocks Conductor Range – 4.0mm ² , Standard Connection	Yellow		20
10134288-008LF	Screw Multilevel Terminal Blocks Conductor Range – 4.0mm ² , Standard Connection	Orange		20
10134288-009LF	Screw Multilevel Terminal Blocks Conductor Range – 4.0mm ² , Standard Connection	Red		20
10134288-010LF	Screw Multilevel Terminal Blocks Conductor Range – 4.0mm ² , Standard Connection	White		20
10134289-001LF	Screw Multilevel Terminal Blocks Conductor Range – 4.0mm ² , Cross Connection	Grey	50	21
10134289-002LF	Screw Multilevel Terminal Blocks Conductor Range – 4.0mm ² , Cross Connection	Black		21
10134289-003LF	Screw Multilevel Terminal Blocks Conductor Range – 4.0mm ² , Cross Connection	Blue		21
10134289-004LF	Screw Multilevel Terminal Blocks Conductor Range – 4.0mm ² , Cross Connection	Yellow Green		21
10134289-005LF	Screw Multilevel Terminal Blocks Conductor Range – 4.0mm ² , Cross Connection	Yellow		21
10134289-006LF	Screw Multilevel Terminal Blocks Conductor Range – 4.0mm ² , Cross Connection	Red		21
10134292-001LF	Accessories – End Plate for Two Stage Screw Terminal Blocks - 2.5 to 4.0mm ²	Grey	50	92

Part Number	Description	Color	Quantity (Pieces) per pack	Page
10134294-001LF	Screw Multilevel Terminal Blocks Conductor Range – 2.5mm ² , Standard Connection	Grey	25	22
10134294-002LF	Screw Multilevel Terminal Blocks Conductor Range – 2.5mm ² , Cross Connection	Grey		23
10134295-001LF	Screw Multilevel Terminal Blocks Conductor Range – 2.5mm ² , Z Type Standard Connection	Grey	25	24
10134295-004LF	Screw Multilevel Terminal Blocks Conductor Range – 2.5mm ² , Z Type Cross Connection	Grey		25
10134297-001LF	Accessories – End Plate for Three Stage Screw Terminal Blocks - 2.5mm ²	Grey	25	92
10134298-001LF	Accessories – End Plate for Three Stage Screw Terminal Blocks - 2.5mm ²	Grey	25	92
10134300-001LF	Screw Universal Terminal Blocks Conductor Range - 4.0mm ²	Grey	50	52
10134308-001LF	Power Terminal Blocks Conductor Range – 70.0mm ²	Beige	10	61
10134309-001LF	Power Terminal Blocks Conductor Range – 95.0mm ²	Beige	10	62
10134310-001LF	Power Terminal Blocks Conductor Range – 120.0mm ²	Beige	10	63
10134311-001LF	Power Terminal Blocks Conductor Range – 150.0mm ²	Beige	10	64
10134312-001LF	Power Terminal Blocks Conductor Range – 185.0mm ²	Beige	10	65
10134313-001LF	Power Terminal Blocks Conductor Range – 240.0mm ²	Beige	10	66
10134314-001LF	Accessories – Blank large marking tags	White	100(2 x 50)	90
10134315-001LF	Accessories – Blank large marking tags	White	100(2 x 50)	90
10134316-001LF	Accessories – Marking tags adapter	Beige	100	91
10134317-001LF	Accessories – Marking tags adapter	Beige	100	91
10134318-001LF	Accessories – Jumper bar for screw terminal blocks 120-150mm ²	Silver	10	99
10134319-001LF	Accessories – Jumper bar for screw terminal blocks 185-240mm ²	Silver	10	99
10134320-001LF	Accessories – Cover for power terminal blocks	Yellow	1	95
10134321-001LF	Accessories – Jumper Bar for screw terminal blocks 70-95mm ²	Silver	10	99
10134322-001LF	Accessories – End Plate for power terminal blocks	Beige	25	95
10134323-001LF	Power Terminal Blocks Conductor Range – 50.0mm ² , Single	Grey	50	67
10134323-002LF	Power Terminal Blocks Conductor Range – 50.0mm ² , Single	Blue		67
10134323-003LF	Power Terminal Blocks Conductor Range – 50.0mm ² , Single	Yellow Green		67
10134324-001LF	Power Terminal Blocks Conductor Range – 50.0mm ² , Multiple	Grey	20	69
10134325-001LF	Power Terminal Blocks Conductor Range – 50.0mm ² , Multiple	Grey	15	68
10134325-002LF	Power Terminal Blocks Conductor Range – 50.0mm ² , Multiple	Blue		68
10134325-003LF	Power Terminal Blocks Conductor Range – 50.0mm ² , Multiple	Yellow Green		68
10134326-001LF	Power Terminal Blocks Conductor Range – 95.0mm ² , Single	Grey	20	70
10134326-002LF	Power Terminal Blocks Conductor Range – 95.0mm ² , Single	Blue		70
10134326-003LF	Power Terminal Blocks Conductor Range – 95.0mm ² , Single	Yellow Green		70
10134327-001LF	Power Terminal Blocks Conductor Range – 95.0mm ² , Multiple	Grey	30	71
10134327-002LF	Power Terminal Blocks Conductor Range – 95.0mm ² , Multiple	Blue		71
10134327-003LF	Power Terminal Blocks Conductor Range – 95.0mm ² , Multiple	Yellow Green		71
10134328-001LF	Power Terminal Blocks Conductor Range – 120.0mm ² , Single	Grey	30	72
10134328-002LF	Power Terminal Blocks Conductor Range – 120.0mm ² , Single	Blue		72
10134328-003LF	Power Terminal Blocks Conductor Range – 120.0mm ² , Single	Yellow Green		72

Part Number	Description	Color	Quantity (Pieces) per pack	Page
10134329-001LF	Power Terminal Blocks Conductor Range – 120.0mm ² , Multiple	Grey	10	73
10134329-002LF	Power Terminal Blocks Conductor Range – 120.0mm ² , Multiple	Blue		73
10134329-003LF	Power Terminal Blocks Conductor Range – 120.0mm ² , Multiple	Yellow Green		73
10134330-001LF	Power Terminal Blocks Conductor Range – 150.0mm ² , Single	Grey	20	74
10134330-002LF	Power Terminal Blocks Conductor Range – 150.0mm ² , Single	Blue		74
10134330-003LF	Power Terminal Blocks Conductor Range – 150.0mm ² , Single	Yellow Green		74
10134331-001LF	Power Terminal Blocks Conductor Range – 150.0mm ² , Multiple	Grey	10	75
10134331-002LF	Power Terminal Blocks Conductor Range – 150.0mm ² , Multiple	Blue		75
10134331-003LF	Power Terminal Blocks Conductor Range – 150.0mm ² , Multiple	Yellow Green		75
10134332-001LF	Power Terminal Blocks Conductor Range – 240.0mm ² , Single	Grey	20	76
10134332-002LF	Power Terminal Blocks Conductor Range – 240.0mm ² , Single	Blue		76
10134332-003LF	Power Terminal Blocks Conductor Range – 240.0mm ² , Single	Yellow Green		76
10134333-001LF	Power Terminal Blocks Conductor Range – 240.0mm ² , Multiple	Grey	6	77
10134333-002LF	Power Terminal Blocks Conductor Range – 240.0mm ² , Multiple	Blue		77
10134333-003LF	Power Terminal Blocks Conductor Range – 240.0mm ² , Multiple	Yellow Green		77
10134334-001LF	Power Terminal Blocks Conductor Range – 70.0mm ²	Grey	24	78
10134335-001LF	Power Terminal Blocks Conductor Range – 120.0mm ²	Grey	12	79
10134336-001LF	Spring Clamp Terminal Blocks Conductor Range – 2.5 to 4.0mm ²	Grey	50	27
10134336-002LF	Spring Clamp Terminal Blocks Conductor Range – 2.5 to 4.0mm ²	Blue		27
10134337-001LF	Spring Clamp Terminal Blocks Conductor Range – 4.0 to 6.0mm ²	Grey	50	28
10134337-002LF	Spring Clamp Terminal Blocks Conductor Range – 4.0 to 6.0mm ²	Blue		28
10134338-001LF	Spring Clamp Terminal Blocks Conductor Range – 6.0 to 10.0mm ²	Grey	50	29
10134338-002LF	Spring Clamp Terminal Blocks Conductor Range – 6.0 to 10.0mm ²	Blue		29
10134339-001LF	Spring Clamp Multilevel Terminal Blocks Conductor Range – 2.5 to 4.0mm ² , 1+2 Levels	Grey	25	30
10134339-002LF	Spring Clamp Multilevel Terminal Blocks Conductor Range – 2.5 to 4.0mm ² , 1+2 Levels	Blue		30
10134340-001LF	Spring Clamp Multilevel Terminal Blocks Conductor Range – 2.5 to 4.0mm ² , Double Levels	Grey	25	31
10134340-002LF	Spring Clamp Multilevel Terminal Blocks Conductor Range – 2.5 to 4.0mm ² , Double Levels	Blue		31
10134341-001LF	Spring Clamp Multilevel Terminal Blocks Conductor Range – 2.5 to 4.0mm ² , Double Levels	Grey	25	32
10134341-002LF	Spring Clamp Multilevel Terminal Blocks Conductor Range – 2.5 to 4.0mm ² , Double Levels	Blue		32
10134341-006LF	Spring Clamp Multilevel Terminal Blocks Conductor Range – 2.5 to 4.0mm ² , Double Levels, Unipolar	Grey	10	33
10134341-007LF	Spring Clamp Multilevel Terminal Blocks Conductor Range – 2.5 to 4.0mm ² , Double Levels, Unipolar	Blue		33
10134342-001LF	Accessories - End Plate for Spring Clamp Terminal Blocks - 2.5mm ²	Grey	50	93
10134343-001LF	Accessories - End Plate for Spring Clamp Terminal Blocks - 4.0mm ²	Grey		93
10134344-001LF	Accessories - End Plate for Spring Clamp Terminal Blocks - 6.0mm ²	Grey		93
10134345-001LF	Accessories - End Plate for Spring Clamp Terminal Blocks - 2.5mm ²	Grey	25	93
10134346-001LF	Accessories - End Plate for Spring Clamp Terminal Blocks - 2.5 to 4.0mm ²	Grey	25	93
10134347-001LF	Accessories - End Plate for Spring Clamp Terminal Blocks - 2.5 to 3.0mm ²	Grey	25	93

Part Number	Description	Color	Quantity (Pieces) per pack	Page
10134348-001LF	Spring Clmap Ground Terminal Blocks Conductor Range – 2.5 to 4.0mm ²	Yellow Green	50	34
10134349-001LF	Spring Clmap Ground Terminal Blocks Conductor Range – 4.0 to 6.0mm ²	Yellow Green	50	35
10134350-001LF	Spring Clmap Ground Terminal Blocks Conductor Range – 6.0 to 10.0mm ²	Yellow Green	50	36
10134351-001LF	Spring Clmap Ground Terminal Blocks Conductor Range – 2.5 to 4.0mm ² , 1+2 Levels	Yellow Green	25	37
10134352-001LF	Spring Clmap Ground Terminal Blocks Conductor Range – 2.5 to 4.0mm ² , Double Levels	Yellow Green	25	38
10134354-001LF	Screw Pluggable Terminal Blocks Conductor Range – 2.5mm ²	Grey	32	40
10134354-002LF	Screw Pluggable Terminal Blocks Conductor Range – 2.5mm ²	Blue		40
10134354-003LF	Screw Pluggable Terminal Blocks Conductor Range – 2.5mm ²	Yellow Green		40
10134355-001LF	Screw Pluggable Terminal Blocks Conductor Range – 2.5mm ² , Double Levels	Grey	32	41
10134355-002LF	Screw Pluggable Terminal Blocks Conductor Range – 2.5mm ² , Double Levels	Blue		41
10134355-003LF	Screw Pluggable Terminal Blocks Conductor Range – 2.5mm ² , Double Levels	Yellow Green		41
10134356-001LF	Screw Pluggable Terminal Blocks Conductor Range – 2.5mm ²	Grey	32	42
10134356-002LF	Screw Pluggable Terminal Blocks Conductor Range – 2.5mm ²	Blue		42
10134356-003LF	Screw Pluggable Terminal Blocks Conductor Range – 2.5mm ²	Yellow Green		42
10134357-001LF	Spring Clamp Pluggable Terminal Blocks Conductor Range – 2.5mm ²	Grey	32	43
10134357-002LF	Spring Clamp Pluggable Terminal Blocks Conductor Range – 2.5mm ²	Blue		43
10134357-003LF	Spring Clamp Pluggable Terminal Blocks Conductor Range – 2.5mm ²	Yellow Green		43
10134358-001LF	Spring Clamp Pluggable Terminal Blocks Conductor Range – 2.5mm ² , Double Levels	Grey	32	44
10134358-002LF	Spring Clamp Pluggable Terminal Blocks Conductor Range – 2.5mm ² , Double Levels	Blue		44
10134358-003LF	Spring Clamp Pluggable Terminal Blocks Conductor Range – 2.5mm ² , Double Levels	Yellow Green		44
10134359-001LF	Spring Clamp Pluggable Terminal Blocks Conductor Range – 2.5mm ²	Grey	32	45
10134359-002LF	Spring Clamp Pluggable Terminal Blocks Conductor Range – 2.5mm ²	Blue		45
10134359-003LF	Spring Clamp Pluggable Terminal Blocks Conductor Range – 2.5mm ²	Yellow Green		45
10134360-001LF	Accessories – End Plate for Pluggable Terminal Blocks – without holes	Grey	25	94
10134360-002LF	Accessories – End Plate for Pluggable Terminal Blocks – with holes	Grey		94
10134361-001LF	Accessories – End Plate for Two Stage Pluggable Terminal Blocks - without holes	Grey	25	94
10134361-002LF	Accessories – End Plate for Two Stage Pluggable Terminal Blocks – with holes	Grey		94
10134362-001LF	Accessories – End Plate for Pluggable Terminal Blocks - without holes	Grey	25	94
10134362-002LF	Accessories – End Plate for Pluggable Terminal Blocks - with holes	Grey		94
10134363-001LF	Accessories – Spacer for Pluggable Terminal Blocks	Grey	25	94
10134364-001LF	Accessories – Spacer for Two Stage Pluggable Terminal Blocks	Grey	25	94

Part Number	Description	Color	Quantity (Pieces) per pack	Page
10134365-001LF	Female Terminal Blocks Conductor Range – 2.5mm ² , 2 poles	Green	200	46
10134365-002LF	Female Terminal Blocks Conductor Range – 2.5mm ² , 3 poles	Green		46
10134365-003LF	Female Terminal Blocks Conductor Range – 2.5mm ² , 4 poles	Green	100	46
10134365-004LF	Female Terminal Blocks Conductor Range – 2.5mm ² , 5 poles	Green		46
10134365-005LF	Female Terminal Blocks Conductor Range – 2.5mm ² , 6 poles	Green		46
10134365-006LF	Female Terminal Blocks Conductor Range – 2.5mm ² , 7 poles	Green	50	46
10134365-007LF	Female Terminal Blocks Conductor Range – 2.5mm ² , 8 poles	Green		46
10134365-008LF	Female Terminal Blocks Conductor Range – 2.5mm ² , 9 poles	Green		46
10134365-009LF	Female Terminal Blocks Conductor Range – 2.5mm ² , 10 poles	Green		46
10134365-010LF	Female Terminal Blocks Conductor Range – 2.5mm ² , 11 poles	Green		46
10134365-011LF	Female Terminal Blocks Conductor Range – 2.5mm ² , 12 poles	Green		46
10134366-001LF	Screw Universal Terminal Blocks Conductor Range – 2.5mm ²	Grey	50	48
10134367-001LF	Spring Cmap Universal Terminal Blocks Conductor Range – 2.5mm ²	Grey	50	53
10134368-001LF	Screw Universal Terminal Blocks Conductor Range – 2.5mm ² , Disconnecter	Grey	50	49
10134369-001LF	Spring Cmap Universal Terminal Blocks Conductor Range – 2.5mm ² , Disconnecter	Grey	50	54
10134370-001LF	Screw Universal Terminal Blocks Conductor Range – 4.0mm ²	Grey	50	50
10134371-001LF	Screw Universal Terminal Blocks Conductor Range – 4.0mm ² , Disconnecter	Grey	50	51
10134372-001LF	Spring Cmap Universal Terminal Blocks Conductor Range – 4.0mm ²	Grey	50	55
10134373-001LF	Spring Cmap Universal Terminal Blocks Conductor Range – 4.0mm ² , Disconnecter	Grey	50	56
10134378-001LF	Accessories – End Plate for Universal Terminal Blocks	Grey	50	95
10134378-002LF	Accessories – Separator for Universal Terminal Blocks	Grey	50	95
10134379-001LF	Equipment for Universal Terminal Blocks – Disconnecting Plug - 25A	Orange	20	57
10134380-001LF	Equipment for Universal Terminal Blocks – Holder for 5x20mm Glass Fuse	Black	20	59
10134381-001LF	Equipment for Universal Terminal Blocks – Holder for 6,3x32mm Glass Fuse	Black	20	59
10134382-001LF	Equipment for Universal Terminal Blocks – Automotive Fuse MIDI - 1A	Black	20	57
10134382-002LF	Equipment for Universal Terminal Blocks – Automotive Fuse MIDI - 2A	Grey		57
10134382-003LF	Equipment for Universal Terminal Blocks – Automotive Fuse MIDI - 3A	Violet		57
10134382-004LF	Equipment for Universal Terminal Blocks – Automotive Fuse MIDI - 4A	Pink		57
10134382-005LF	Equipment for Universal Terminal Blocks – Automotive Fuse MIDI - 5A	Beige		57
10134382-006LF	Equipment for Universal Terminal Blocks – Automotive Fuse MIDI - 7.5A	Brown		57
10134382-007LF	Equipment for Universal Terminal Blocks – Automotive Fuse MIDI - 10A	Red		57
10134382-008LF	Equipment for Universal Terminal Blocks – Automotive Fuse MIDI - 15A	Blue		57
10134382-009LF	Equipment for Universal Terminal Blocks – Automotive Fuse MIDI - 20A	Yellow		57
10134382-010LF	Equipment for Universal Terminal Blocks – Automotive Fuse MIDI - 25A	White		57
10134382-011LF	Equipment for Universal Terminal Blocks – Automotive Fuse MIDI - 30A	Green	57	

Part Number	Description	Color	Quantity (Pieces) per pack	Page
10134383-001LF	Equipment for Universal Terminal Blocks – Auto-resettable Thermal Automotive Circuit Breaker - 6A	Green	20	57
10134383-002LF	Equipment for Universal Terminal Blocks – Auto-resettable Thermal Automotive Circuit Breaker - 8A	Yellow		57
10134383-003LF	Equipment for Universal Terminal Blocks – Auto-resettable Thermal Automotive Circuit Breaker - 10A	Red		57
10134383-004LF	Equipment for Universal Terminal Blocks – Auto-resettable Thermal Automotive Circuit Breaker - 15A	Blue		57
10134383-005LF	Equipment for Universal Terminal Blocks – Auto-resettable Thermal Automotive Circuit Breaker - 25A	White		57
10134384-001LF	Equipment for Universal Terminal Blocks – Resettable Thermal Automotive Circuit Breaker - 6A	Green	20	58
10134384-002LF	Equipment for Universal Terminal Blocks – Resettable Thermal Automotive Circuit Breaker - 8A	Yellow		58
10134384-003LF	Equipment for Universal Terminal Blocks – Resettable Thermal Automotive Circuit Breaker - 10A	Red		58
10134384-004LF	Equipment for Universal Terminal Blocks – Resettable Thermal Automotive Circuit Breaker - 15A	Blue		58
10134384-005LF	Equipment for Universal Terminal Blocks – Resettable Thermal Automotive Circuit Breaker - 25A	White		58
10134385-001LF	Equipment for Universal Terminal Blocks – Automotive Circuit Breaker with Manual Release Option - 6A	Green	20	58
10134385-002LF	Equipment for Universal Terminal Blocks – Automotive Circuit Breaker with Manual Release Option - 8A	Yellow		58
10134385-003LF	Equipment for Universal Terminal Blocks – Automotive Circuit Breaker with Manual Release Option - 10A	Red		58
10134385-004LF	Equipment for Universal Terminal Blocks – Automotive Circuit Breaker with Manual Release Option - 15A	Blue		58
10134385-005LF	Equipment for Universal Terminal Blocks – Automotive Circuit Breaker with Manual Release Option - 25A	White		58
10134386-001LF	Equipment for Universal Terminal Blocks – Miniaturized Single Pole Thermal Circuit Breaker with Switching Function (Push-push Actuation) - 0.25A	Black	20	58
10134386-002LF	Equipment for Universal Terminal Blocks – Miniaturized Single Pole Thermal Circuit Breaker with Switching Function (Push-push Actuation) - 0.5A	Black		58
10134386-003LF	Equipment for Universal Terminal Blocks – Miniaturized Single Pole Thermal Circuit Breaker with Switching Function (Push-push Actuation) - 1A	Black		58
10134386-004LF	Equipment for Universal Terminal Blocks – Miniaturized Single Pole Thermal Circuit Breaker with Switching Function (Push-push Actuation) - 2A	Black		58
10134386-005LF	Equipment for Universal Terminal Blocks – Miniaturized Single Pole Thermal Circuit Breaker with Switching Function (Push-push Actuation) - 3A	Black		58
10134386-006LF	Equipment for Universal Terminal Blocks – Miniaturized Single Pole Thermal Circuit Breaker with Switching Function (Push-push Actuation) - 4A	Black		58

Part Number	Description	Color	Quantity (Pieces) per pack	Page
10134386-007LF	Equipment for Universal Terminal Blocks – Miniaturized Single Pole Thermal Circuit Breaker with Switching Function (Push-push Actuation) - 6A	Black	20	58
10134386-008LF	Equipment for Universal Terminal Blocks – Miniaturized Single Pole Thermal Circuit Breaker with Switching Function (Push-push Actuation) - 8A	Black		58
10134386-009LF	Equipment for Universal Terminal Blocks – Miniaturized Single Pole Thermal Circuit Breaker with Switching Function (Push-push Actuation) - 10A	Black		58
10134387-001LF	Accessories – Angled Support Bracket	Silver	50	97
10134389-001LF	Accessories – End Bracket for DIN Rail – Width 9mm	Grey	50	97
10134390-001LF	Accessories – End Bracket for DIN Rail – Width 6mm	Black	50	97
10134391-001LF	Accessories – Fast Snap End Bracket for DIN Rail	Black	50	97
10134392-001LF	Accessories – Steel Omega Rail 35 x 7.5mm - 2metres	-	20 bars of 2m each	97
10134393-001LF	Accessories – Slotted Steel Omega Rail 35 x 7.5mm - 2metres	-		97
10134394-001LF	Accessories – Steel Omega Rail 35 x 15mm - 2metres	-	10 bars of 2m each	97
10134395-001LF	Accessories – Slotted Steel Omega Rail 35 x 15mm - 2metres	-		97
10134397-001LF	Accessories – Blank large marking tags for spring clamp terminals	White	500(10 x 50)	87
10134398-001LF	Accessories – Blank single-digit marking tags	White	100(20 x 5)	87
10134398-002LF~041LF	Accessories – Printed single-digit marking tags	White	100(20 x 5)	87~88
10134399-001LF	Accessories – Marking tag adapter	White	50	91
10134400-001LF	Accessories – Blank large marking tags for screw terminals	White	500(25 x 20)	89
10134401-001LF	Accessories – Blank large marking tags for screw terminals	White	500(10 x 50)	89
10134402-001LF	Accessories – Blank large marking tags for screw terminals	White	500(10 x 50)	89
10134414-001LF	Accessories – Jumper Bar 5.1mm pitch - 2 Poles	Blue	100	100
10134414-002LF	Accessories – Jumper Bar 5.1mm pitch - 3 Poles	Blue		100
10134414-003LF	Accessories – Jumper Bar 5.1mm pitch - 12 Poles	Blue	10	100
10134414-004LF	Accessories – Jumper Bar 5.1mm pitch - 2 Poles	Red	100	100
10134414-005LF	Accessories – Jumper Bar 5.1mm pitch - 3 Poles	Red		100
10134414-006LF	Accessories – Jumper Bar 5.1mm pitch - 12 Poles	Red	10	100
10134419-001LF	Accessories – Vertical marking tags - 10 poles	White	500(50 x 10)	90
10134420-001LF	Accessories – Jumper Bar 9.1mm pitch - 12 Poles	Blue	10	100
10134421-001LF	Accessories – Spacer for Pluggable Terminal Blocks	Grey	25	94

Part Number	Description	Color	Quantity (Pieces) per pack	Page
10134436-001LF	Screw Test and Measurement Terminal Blocks Conductor Range - 6mm ² , Disconnect slider	Grey	40	81
10134437-001LF	Screw Test and Measurement Terminal Blocks Conductor Range - 6mm ² , Amperometric	Grey	40	82
10134438-001LF	Screw Test and Measurement Terminal Blocks Conductor Range - 6mm ² , Voltmetric	Grey	40	83
10134439-001LF	Spring Clamp Test and Measurement Terminal Blocks Conductor Range - 6mm ² , Disconnect slider	Grey	40	84
10134440-001LF	Spring Clamp Test and Measurement Terminal Blocks Conductor Range - 6mm ² , Amperometric	Grey	40	85
10134441-001LF	Spring Clamp Test and Measurement Terminal Blocks Conductor Range - 6mm ² , Voltmetric	Grey	40	86
10134442-001LF	Accessories – End Plate	Grey	20	95
10134443-001LF	Accessories – Separator	Red	20	95
10134444-001LF	Accessories – Insulated Slider Jumper - 2 poles	Red	20	100
10134445-001LF	Accessories – Insulated Slider Jumper - 4 poles	Red	20	100
10134446-001LF	Accessories – Insulated Test Plug Socket	Red	20	96
10134447-001LF	Accessories – Insulated Test Plug Socket	Black	20	96
10134448-001LF	Accessories – Marking Tags	White	900(20 x 45)	90
10134449-001LF	Accessories – Marking Tags	White	780(20 x 39)	90
10134450-001LF	Accessories – Marking Tags	White	675(25 x 27)	90

ANYTEK[®]

Anytek Electronic Technology (SZ) Co., Ltd.
恩尼特克电子科技(深圳)有限公司

Web Site: <http://www.anytek.com.tw>
<http://www.anytek.com.cn>
E-mail: anytek@anytek.com.cn

Taiwan Taipei

新北市汐止区新台五路一段77号5楼之6
5F-6, No.77, Sec. 1, Xintai 5th Rd., Xizhi Dist.,
New Taipei City 22175, Taiwan, R.O.C.
Tel: +886-(0)2-26980366
Fax: +886-(0)2-26980377
E-mail: anytek@anytek.com.tw

China Shenzhen Factory

中国深圳市龙岗区坪地街道中心社区佳乐路10号A栋
Building A, No.10, Jiale Road, Center Community, Pingdi
Street, Longgang District, Shenzhen City, China
工厂电话(Tel): +86-(0)755-84096008/84096242
工厂传真(Fax): +86-(0)755-84096027
销售电话(Tel): +86-(0)755-36518520/36518521
销售传真(Fax): +86-(0)755-36518522
E-mail: anytek@anytek.com.cn

China Shanghai Office & Factory

中国上海市浦东金桥工业区宁桥路825号4栋2楼北面
North Site, 2F, 4th Building, No.825, Ningqiao Road,
Pudong, Shanghai City, China
Tel: +86-(0)21-58999106
Fax: +86-(0)21-58993286
E-mail: anytek@anytek.com.cn

China Beijing Office

北京市海淀区上地十街1号院4号楼903室
Room 903, 4th Building, No.1 Yard, Shangdi
10th Road, Haidian District, Beijing City, China
Tel: +86-(0)10-59741768/59741769
Fax: +86-(0)10-59741667
E-mail: anytek@anytek.com.cn

Korea Branch Office & Factory

101, 1F, 728-6, Kumjung-Dong, Kunpo-City,
Kyounggi-Do, Korea
Tel: +82-(0)31-4557920
Fax: +82-(0)31-4548844
E-mail: dhkoh@anytekkorea.com

Q-FLEX

www.q-flex.fi info@q-flex.fi
+358 2 4894 500

WARNING:

All the copyrights of this book belong to ANYTEK Technology corporation Ltd., and it's prohibited for duplication.
Once the duplication has been found, we will suit for law.

NOTE:

The information furnished by ANYTEK has been carefully checked and is believed to be assumed by ANYTEK.
For its use, nor for an infringements of patents or other rights of third parties that may result from its use.
ANYTEK retains the rights to make changes in the publication without prior notice.